



# Instruction Manual



## **FLEXI-FLOW™ Compact**

Doc. no.: 9.17.158 rev. F    Date: 19-03-2024

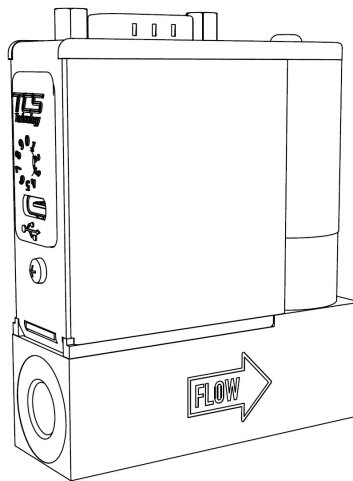

### **ATTENTION**

**Please read this document carefully before installing and operating the product.  
Not following the guidelines could result in personal injury and/or damage to the equipment.  
Keep this document for future reference.**



## Copyright

© 2024 Bronkhorst High-Tech B.V. - All rights reserved.

Bronkhorst® is a registered trademark of Bronkhorst High-Tech B.V.  
All other trademarks are the property of their respective owners.

## Disclaimer

The illustrations in this document serve to provide general notices regarding correct operation. Illustrations are simplified representations of the actual situation and may differ from the actual product.

Bronkhorst High-Tech B.V. reserves the right to modify or improve its products and documentation without notice. Prior to work, check whether a newer version of this document is available on the Bronkhorst website.

## Symbols in this document



*Important information. Disregarding this information could increase the risk of damage to the equipment, or the risk of personal injuries.*



*Tips, useful information, attention points. This will facilitate the use of the instrument and/or contribute to its optimal performance.*



*Additional information available in the referenced documentation, on the indicated website(s) or from your Bronkhorst representative.*

## Service

If you have a question about a product or if you find the product does not meet the specifications as ordered, do not hesitate to contact your Bronkhorst representative. To enable us to help you quickly and effectively, make sure to have the serial number (SN) ready whenever seeking contact with your Bronkhorst representative about a specific item.

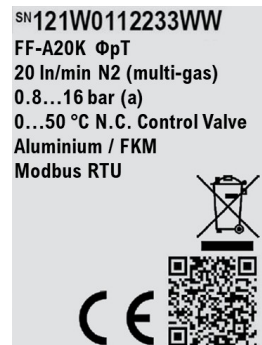

For current information about Bronkhorst® and worldwide service addresses, please visit our website:



[www.bronkhorst.com](http://www.bronkhorst.com)

Do you have any questions about our products? Our Sales department will gladly assist you selecting the right product for your application. Contact sales by e-mail:



[sales@bronkhorst.com](mailto:sales@bronkhorst.com)

For after-sales questions, help and guidance, our Customer Care department is available by e-mail:



[aftersales@bronkhorst.com](mailto:aftersales@bronkhorst.com)

No matter the time zone, our experts within the Customer Care department are available to answer your request immediately or take appropriate further action. Our experts can be reached at:



**+31 859 02 18 66**

Bronkhorst High-Tech B.V.  
Nijverheidsstraat 1A  
NL-7261 AK Ruurlo  
The Netherlands

## Warranty

For information about the warranty and the conditions of sales, please visit the Bronkhorst website:

[www.bronkhorst.com/about/conditions-of-sales/](http://www.bronkhorst.com/about/conditions-of-sales/)

## Receipt of equipment

- Check that the outer packaging and its contents have not been damaged during transport. If the outer packaging or its contents are damaged, the local carrier must be informed immediately regarding his liability, if so required. At the same time a report should be submitted to your Bronkhorst representative.
- If the product is damaged, it should not be put into service. In that case, contact your Bronkhorst representative for service.
- Check the packing list to ensure that you received all items included in the scope of delivery.
- Do not discard spare or replacement parts.
- See [Removal and return instructions](#)<sup>126</sup> for information about return shipment procedures.

## Equipment storage

- The equipment should be stored in its original package in a climate controlled storage location.
- Care should be taken not to subject the equipment to excessive temperatures or humidity.
- See technical specifications (data sheet) for information about required storage conditions.



## Table of contents

<b>1</b>	<b>General information</b>	<b>7</b>
1.1	Scope of this document	7
1.2	Intended use	7
1.3	Product overview	8
1.4	Product features	10
1.4.1	Offline/parallel configuration	10
1.4.2	NAMUR instrument status	10
1.4.3	Multi-parameter functionality	10
1.4.4	On-board FLUIDAT® database	10
1.4.5	Multi-channel systems	10
1.5	Documentation	11
1.6	Safety notes	12
<b>2</b>	<b>Installation</b>	<b>14</b>
2.1	Product specifications	14
2.1.1	Pressure rating	14
2.1.2	Bluetooth certification	14
2.2	Mounting	14
2.2.1	Piping requirements	15
2.2.2	Fluid connection	15
2.2.3	Preventing pressure shocks	15
2.3	Electrical connection	16
2.4	Fieldbus connection	16
<b>3</b>	<b>Operation</b>	<b>17</b>
3.1	General procedures	17
3.1.1	Powering up	17
3.1.2	First use	17
3.1.3	After use	17
3.1.4	Powering down	17
3.1.5	Instrument status	18
3.1.6	Shut-off valve status	18
3.2	Special procedures	18
3.2.1	Changing fieldbus settings (FLOW-BUS/Modbus)	18
3.2.2	Changing fieldbus settings (Ethernet)	19
3.2.3	Fluid selection	19
3.2.4	Customizing shut-off valve behavior (FF-annS only)	20
3.2.5	Switching control function	21
3.2.6	Bluetooth configuration	22
3.2.7	Adjusting zero point	22
3.3	Maintenance	23
3.3.1	Cleaning	23
3.3.2	Calibration	23
3.4	Troubleshooting	23
3.4.1	Zooming in on NAMUR status	24
3.4.2	Default valve state	24
3.4.3	Common issues	24

3.5	Returns .....	26
3.5.1	Removal and return instructions .....	26
3.5.2	Disposal (end of lifetime) .....	26
<b>4</b>	<b>Communication interface .....</b>	<b>27</b>
4.1	Configuration .....	27
4.2	Communication protocol .....	27
4.3	Parameters .....	28
4.3.1	Measurement and control .....	29
4.3.1.1	Advanced measurement and control .....	30
4.3.2	Alarms .....	30
4.3.3	Counter .....	32
4.3.4	Network configuration .....	34
4.3.4.1	Node address settings .....	35
4.3.4.2	IP address settings .....	36
4.3.5	Fluid set .....	36
4.3.5.1	Advanced fluid set parameters .....	37
4.3.5.2	Fluid mixture parameters .....	38
4.3.6	Master/slave configuration (FLOW-BUS) .....	39
4.3.7	Shut-off valve settings (FF-annS only) .....	40
4.3.8	Device identification .....	41
4.3.9	Bluetooth .....	42
4.3.10	Operational history .....	43
4.3.11	Diagnostics .....	44
4.3.12	Special parameters .....	45
4.4	Multi-parameter addressing .....	47
4.5	Gateway (multi-channel systems) .....	48
	<b>Parameter index .....</b>	<b>51</b>

# 1 General information

## 1.1 Scope of this document

This document contains information for basic installation, commissioning, operation and maintenance of the following **FLEXI-FLOW™ Compact** models:

Model name	Model code*
Preconfigured Standard flow controller	FF-Sxxx
Preconfigured Advanced flow controller	FF-Axxx
Flow meter/controller	FF-ann
Flow controller with down ported fluid connectors	FF-annD
Flow controller with integrated shut-off valve	FF-annS

\*) a=letter, n=digit, x=letter or digit

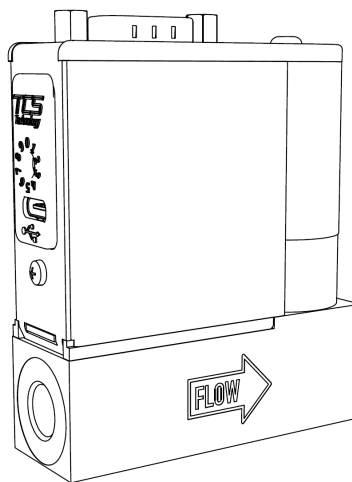

## 1.2 Intended use

The FLEXI-FLOW has been developed to measure and/or control mass flow rates and pressures of clean, dry, non-corrosive and non-toxic gases in a fluid system.

The product is suited for general purpose dry indoor applications, like laboratories and machine enclosures, applying media and operating conditions within the limits as specified in the [FLEXI-FLOW™ Compact datasheet](#)<sup>11</sup>.

Any other use is considered as not intended and improper. Improper use might cause damage to the product and/or pose danger to users and/or bystanders and is therefore not permissible.

Responsibility for application of the product in accordance with its intended use, suitability for the intended application, cleaning and compatibility of the used media with the applied materials lies solely with the user.

Bronkhorst High-Tech B.V. cannot be held liable for any damage and/or injury resulting from unintended, improper or unsafe use.

### 1.3 Product overview

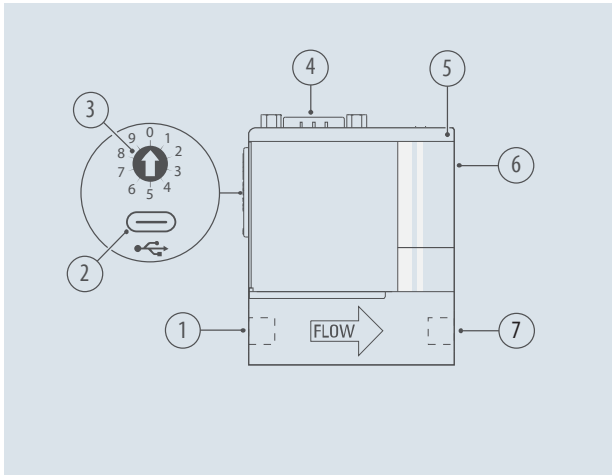

#### FF-ann / FF-Sxxx / FF-Axxx

1. Fluid inlet
2. Support interface (USB-C)
3. Address selector
4. Power and signal connector (9-pin D-sub)
5. Status LED
6. Control valve (only MFC)
7. Fluid outlet

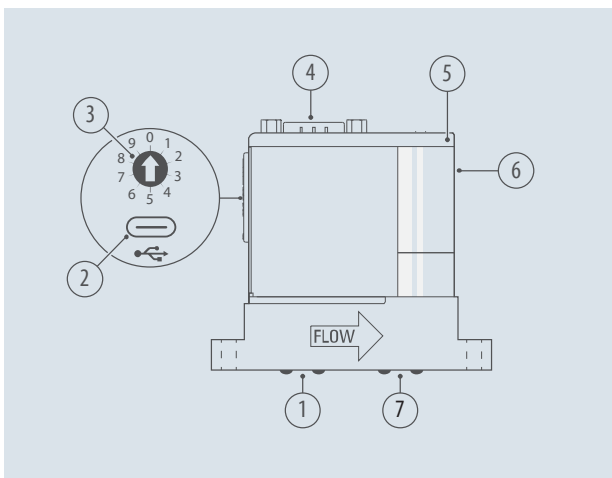

#### FF-annD (down ported fluid connectors)

1. Fluid inlet
2. Support interface (USB-C)
3. Address selector
4. Power and signal connector (9-pin D-sub)
5. Status LED
6. Control valve (only MFC)
7. Fluid outlet

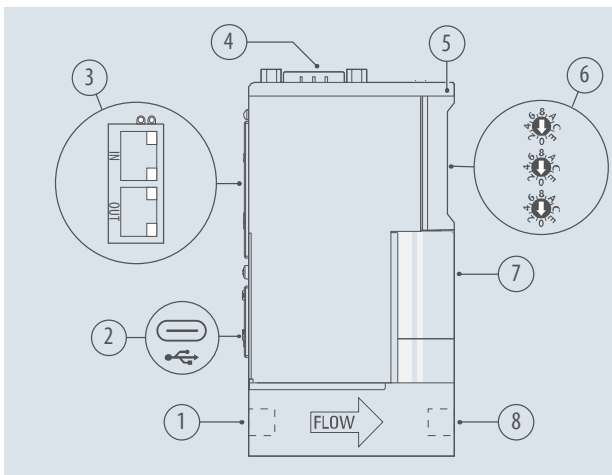

#### FF-ann / FF-annD with Ethernet interface

1. Fluid inlet
2. Support interface (USB-C)
3. Ethernet interface
4. Power and signal connector (9-pin D-sub)
5. Status LED
6. Address selectors
7. Control valve (only MFC)
8. Fluid outlet

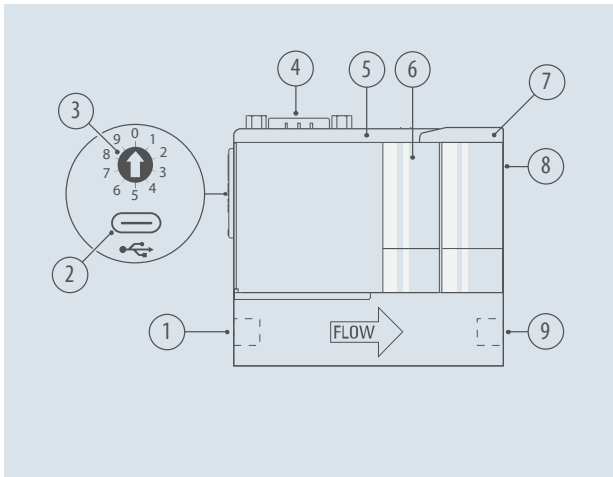

**FF-annS (with integrated shut-off valve)**

1. Fluid inlet
2. Support interface (USB-C)
3. Address selector
4. Power and signal connector (9-pin D-sub)
5. Status LED (controller)
6. Control valve
7. Status LED (shut-off valve)
8. Shut-off valve
9. Fluid outlet

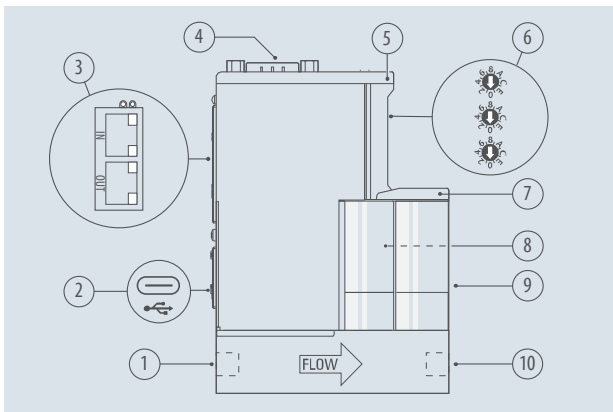
**FF-annS with Ethernet interface**

1. Fluid inlet
2. Support interface (USB-C)
3. Ethernet interface
4. Power and signal connector (9-pin D-sub)
5. Status LED (controller)
6. Address selectors
7. Status LED 9 (shut-off valve)
8. Control valve
9. Shut-off valve
10. Fluid outlet

## 1.4 Product features

### 1.4.1 Offline/parallel configuration

The instrument is fitted with a support interface (USB-C) and an optional Bluetooth® wireless connection. Both interfaces can be used to [configure the instrument](#)<sup>27</sup> before process integration. After process integration, both connections can also be used to monitor the instrument without disconnecting the operational communication connection.

**Note:** All information in this document regarding the Bluetooth® functionality of the FLEXI-FLOW does not apply to instruments ordered without this functionality.

### 1.4.2 NAMUR instrument status

With the [status indication LED](#)<sup>8</sup>, the FLEXI-FLOW™ Compact shows its [current status](#)<sup>18</sup>, using a color range based on the NAMUR NE 107 standard. The colors provide easily recognizable signals to the operator regarding corrective actions, malfunctions, maintenance indications, etc.



Comprehensive diagnostic information based on the NAMUR status is available in Bronkhorst FlowSuite.

### 1.4.3 Multi-parameter functionality

Upon delivery, the FLEXI-FLOW™ Compact is configured as a (mass) flow controller or meter. 2 integrated pressure sensors provide additional real-time measurement data, and allow the main instrument function to be [switched between flow control and pressure control](#)<sup>21</sup>. Upon request, the instrument can also be supplied without this functionality. More real-time measurement data is provided by an on-board temperature sensor.

### 1.4.4 On-board FLUIDAT® database

A built-in database with properties of 22 commonly used gases provides the basis for up to 8 fluid presets, which can be stored in the instrument using Bronkhorst FlowSuite or by direct digital communication (e.g. using a custom-built (PLC) program).

The on-board FLUIDAT® conversion algorithm continuously adjusts the gas flow relative to the calibration gas, based on the measured temperature and pressure and the properties of the [selected gas \(or mixture\)](#)<sup>19</sup>.

### 1.4.5 Multi-channel systems

The FLEXI-FLOW™ Compact can be supplied as a multi-channel system with up to 8 instruments which are linked fluidically by means of a manifold-like construction. The instruments can be controlled individually with Modbus RTU, FLOW-BUS or an Ethernet based communication protocol, or through a [gateway](#)<sup>48</sup> in other fieldbus systems. The gateway and the instruments behind it are powered through a single cable.



For information about FLEXI-FLOW™ Compact based multi-channel systems and possible applications, contact your Bronkhorst representative.

## 1.5 Documentation



- At some points this document refers to documentation associated with important components or features.
- The documents listed in the following table are available on the FLEXI-FLOW product page ([www.bronkhorst.com/flexi-flow](http://www.bronkhorst.com/flexi-flow) or scan the QR code).



Type	Document name	Document no.
Manuals	Instruction Manual FLEXI-FLOW™ Compact (this document)	9.17.158
	Quick Start Guide FLEXI-FLOW™ Compact	9.17.182
	Quick Start Guide FLEXI-FLOW™ Compact FF-annS	9.17.186
	Mounting Instruction Compression Fittings	9.17.170
	Mounting Instruction Push-in Fittings	9.17.171
	Mounting Instruction FF-annD	9.17.181
Technical documentation	Datasheet (technical specifications)	-
	Hook-up diagram Ethernet based	9.16.313
	Hook-up diagram Ethernet based (FF-annS)	9.16.314
	Hook-up diagram Modbus RTU / FLOW-BUS	9.16.275
	Hook-up diagram Modbus RTU / FLOW-BUS (FF-annS)	9.16.276
	Hook-up diagram Modbus RTU / FLOW-BUS (Multi-channel)	9.16.296
	Hook-up diagram PROFINET (Multi-channel)	9.16.297
	Hook-up diagram PROFIBUS DP (Multi-channel)	9.16.298
	Dimensional drawing FF-a0n	7.15.287
	Dimensional drawing FF-a1n	7.15.225
	Dimensional drawing FF-a2n	7.15.288
	Dimensional drawing FF-annD	7.15.285
	Dimensional drawing FF-annS	7.15.286



The documents listed in the following table can be downloaded from [www.bronkhorst.com/downloads](http://www.bronkhorst.com/downloads).

Type	Document name	Document no.
Manuals	Manual EtherCAT® interface	9.17.063
	Manual EtherNet/IP™ interface	9.17.132
	Manual FLOW-BUS interface	9.17.024
	Manual Modbus interface (RTU & TCP)	9.17.035
	Manual POWERLINK interface	9.17.142
	Manual PROFINET interface	9.17.095
	Manual RS-232 interface*	9.17.027
Compliance	EU Declaration of Conformity FLEXI-FLOW	9.06.132
	EU Declaration of Conformity RoHS	9.06.124
	Manufacturer Declaration REACH	9.06.056
	Manufacturer Declaration WEEE	9.06.128
	Conflict Minerals Compliance Policy	9.06.065

\*) Note that the FLEXI-FLOW has no RS-232 communication interface. The RS-232 manual provides useful information about the ProPar protocol.

## 1.6 Safety notes



**Please read this document entirely and carefully before installing and operating the product. Not following the guidelines could result in personal injury and damage to the product and the system(s) it is incorporated in or connected with.**

- The product(s) described in this document may only be handled by qualified personnel who are familiar with combined fluid and electrical systems and who recognize the associated hazards (e.g. (high) fluid pressure, electric shock).
- The user is responsible for taking the necessary safety measures to prevent damage and/or injury while working with the equipment and process media (as described in the associated Material Safety Data Sheets).
- Where appropriate, this document recommends or prescribes safety measures to be taken with respect to media or equipment usage under the specified conditions. However, this does not relieve the user of aforementioned responsibility, not even if such is not explicitly recommended or prescribed in this document.
- The equipment and its accessories must be used in accordance with their specifications and intended use.
- The customer is responsible for conducting a risk analysis for the entire system and take the required safety precautions, following applicable laws and regulations. Based on the risk analysis, the customer should describe and adhere to standard operating procedures to ensure safe use of the equipment.
- Individual instruments may not be disassembled or modified in any way or for any purpose.
- Any unauthorized modification, for any purpose whatsoever, will be considered as [unintended and improper use](#)<sup>17</sup>, will void warranty and cancel the manufacturer's liability.
- Unauthorized modifications can undo safety features, compromise system specifications (such as ingress protection rating) and cause failure to comply with applicable laws, regulations and directives.
- If the product is defective or otherwise does not meet your requirements, please contact your Bronkhorst representative for assistance or advice.

### Product related safety warnings



Before operating the FLEXI-FLOW, make sure that the equipment has been installed and configured by an authorized engineer and that the installation is approved for use.



To ensure and maintain a safe working area, regularly inspect electrical and fluid lines and connections:

- Prior to each use, check cabling for proper connection, damage and wear. If necessary, replace cables and/or connectors.
- Before, during and after operation, check fluid lines and connections for leaks, damage and wear. If necessary, re-tighten or replace fluid connectors.



During operation, fluid connections must not be loosened or disconnected under any circumstances.



When pressurizing, prevent pressure shocks by gradually bringing the fluid system to the required operating pressure.



Bronkhorst does the utmost to ensure that you receive a clean product. This does not, however, relieve the user of the responsibility to ensure that the equipment and the system in which it is incorporated meet the requirements implied by the intended use of the product. The responsibility for cleaning the equipment to meet such requirements lies exclusively with the user.



- Depending on the properties of the process medium and the (expected) time until the next use, it is advisable to flush the fluid system with a suitable (cleaning) fluid after use.
- If the equipment has been used to process corrosive, reactive or hazardous media (e.g. toxic or flammable), cleaning the fluid system is imperative before it is exposed to air.
- If the equipment is not used for an extended period, the fluid system should be dry after use and after cleaning. If not, it should be purged with a dry, inert gas for a minimum period of 30 minutes.



- Prior to powering down the FLEXI-FLOW, the fluid system should be depressurized.
- When depressurizing, prevent pressure shocks by shutting off the fluid supply gradually.



Inexpertly servicing instruments can lead to serious personal injury and/or damage to the instrument or the system it is used in. Servicing must therefore be performed by trained and qualified personnel. Contact your Bronkhorst representative for information about cleaning and calibration. Bronkhorst has trained staff available.



- Before disconnecting or disassembling any fluid system related parts, always make sure the fluid system is depressurized to atmospheric pressure.
- When depressurizing, prevent sudden pressure changes by shutting off the fluid supply gradually.

## 2 Installation

### 2.1 Product specifications

Before installing the FLEXI-FLOW, check that the functional and technical properties of the product match your requirements (the image on the right is an example; it does not necessarily reflect the actual specifications of your instrument).

If you have a question about the product or if you find the product does not meet the specifications as ordered, do not hesitate to contact your Bronkhorst representative (see the first pages of this document for contact information).

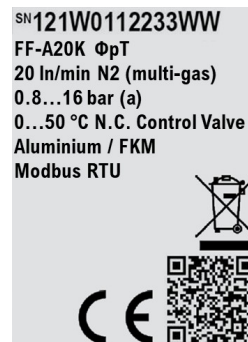

#### 2.1.1 Pressure rating



A red label signifies that the FLEXI-FLOW has undergone a pressure test and a test for outboard leakage.

- If the red label is missing, the device must not be used and should be returned to the factory.
- Before installation, make sure that the pressure rating is within the limits of the normal process conditions of your application.

Pressure tested  
Leak tested

#### 2.1.2 Bluetooth certification

##### Connectivity

Bluetooth version	5.2
Frequency range	2402...2480 MHz
Transmitter power	max. +6 dBm
Range	max. 75 m

##### FCC (USA): YCP-STM32WB5M001

Note: This equipment has been tested and found to comply with the limits for a Class A digital device, pursuant to part 15 of the FCC Rules. These limits are designed to provide reasonable protection against harmful interference when the equipment is operated in a commercial environment. This equipment generates, uses, and can radiate radio frequency energy and, if not installed and used in accordance with the instruction manual, may cause harmful interference to radio communications. Operation of this equipment in a residential area is likely to cause harmful interference in which case the user will be required to correct the interference at his own expense.

##### ISED (Canada): 8976A-STM32WB5M01

Notes: This device contains licence-exempt transmitter(s)/receiver(s) that comply with Innovation, Science and Economic Development Canada's licence-exempt RSS(s). Operation is subject to the following two conditions:

1. This device may not cause interference.
2. This device must accept any interference, including interference that may cause undesired operation of the device.

##### JRF (Japan): 005-102490

##### NCC (Taiwan): CCAN20LP0740T3

### 2.2 Mounting



For optimal performance, observe the following guidelines:

- Avoid installation in close proximity of mechanical vibration and/or heat sources.
- Use the equipment in an environment with a stable ambient pressure and temperature.
- Attach the instrument body to a rigid and stable surface or construction.

### Instrument with regular fluid couplings

Use the threaded mounting holes in the bottom of the instrument base. Consult the [dimensional drawing](#)<sup>11</sup> for the exact size and locations.

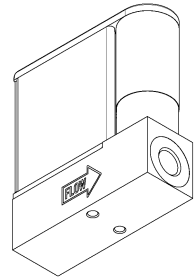

### Instrument with down ported fluid couplings

- Consult the [dimensional drawing](#)<sup>11</sup> for details about the instrument footprint and mounting pattern.
- Follow the [mounting instructions for FF-annD instruments](#)<sup>11</sup>.

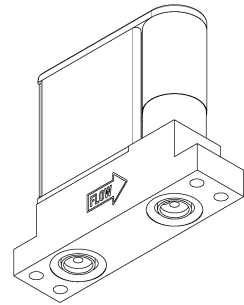

## 2.2.1 Piping requirements



- For reliable performance, make sure the fluid stream is uncontaminated. If necessary, use an inlet filter to ensure a particle free media stream. Select a filter with a maximum pore size of 20 µm and a surface area that minimizes the pressure drop.
- If back flow could occur, the use of a check valve is also recommended.



Use piping or tubing that is suitable for the operating conditions of the application (media, maximum temperature, maximum operating pressure).

## 2.2.2 Fluid connection

- Connect the FLEXI-FLOW to the fluid system in accordance with the indications in the [product overview](#)<sup>8</sup>.
- Consult the [dimensional drawing](#)<sup>11</sup> for the according instrument model for details about the fitting cavities.
- Make sure connector sizes match; do not mix metric (mm) and imperial (inch) sizes.
- Make sure all connectors and tubing are free from dirt and debris.
- Follow the [mounting instructions](#)<sup>11</sup> for the according fluid connectors.



Do not apply fluid pressure until all required fluid connections and electrical connections have been made.



Check the fluid system for leak tightness after any modification and before applying full operating pressure, especially when using hazardous media (e.g. toxic or flammable).

## 2.2.3 Preventing pressure shocks



FLEXI-FLOW instruments can handle pressure shocks in the system well, but are not insensitive to pressure fluctuations. For optimal control stability, observe the following guidelines:

- Provide a stable (pressure controlled) upstream pressure; put sufficient buffer volume between a pressure regulator and the instrument. As a rule of thumb, install pressure regulators at a distance of at least 25 times the pipe diameter from the inlet or outlet of the instrument.
- When using multiple instruments and/or control valves, prevent interference by putting piping with sufficient buffer volume between components.

## 2.3 Electrical connection

- Electrical connections should be made according to the applicable [hook-up diagram](#)<sup>11</sup>, using the supplied cables (insofar as included) or compatible, with respect to required supply current, voltage loss, cable length, cable and gland diameters and operating conditions.
- When using self-assembled cables, follow the guidelines provided by the connectors' manufacturer.
- For use in a fieldbus system, follow the instructions of the cable supplier for the according fieldbus system.
- Make sure that the power supply matches the power rating of the instrument (see [technical specifications](#)<sup>11</sup>) and that double or reinforced insulation is used for the power supply.
- If a surge protection device is used, make sure its specifications match the power consumption of the application.



To prevent damage as a result of reversed polarity, the use of a 2A fuse in the direct +Us line is recommended.



Always turn off electrical power before connecting or disconnecting equipment electrically.



In order to be able to comply with all applicable guidelines and regulations, it is imperative that electrical connections be made by or under supervision of a qualified electrician.



- The equipment described in this document contains electronic components that are susceptible to **electrostatic discharge**.
- When working on the electrical installation, take appropriate measures to prevent damage as a result of electrostatic discharge.



The **CE mark** on the equipment indicates that it complies with requirements imposed by the European Union. The **UKCA mark** indicates compliance with requirements imposed by the United Kingdom.

In both cases, the requirements include **electromagnetic compatibility (EMC)**.

EMC can only be guaranteed by applying appropriate cables and connectors or gland assemblies:

- Cable wire diameters must be sufficient to carry the supply current and minimize voltage loss.
- When connecting the product to other devices, ensure that the integrity of the shielding remains uncompromised; use shielded cables and connectors where possible and/or required.
- Preferably use the supplied cables (if applicable) to make electrical (signal) connections to and between the supplied components. These cables are shielded, have the required wire diameter, and loose ends (if applicable) are marked to facilitate correct connection.

If not all requirements for proper shielding can be met (for example, because a component is not equipped with shielded connectors), take the following measures to ensure the best possible shielding:

- Keep cable lengths at a minimum.
- Route cables as closely as possible alongside metal structures or components.
- Ensure all electrical components are grounded to earth.

When in doubt about the shielding of your cabling and/or electrical connections, contact your Bronkhorst representative.

## 2.4 Fieldbus connection



Always check the total power consumption of your instruments before connecting them to a fieldbus system. Do not exceed the maximum power of the power supply unit.



- For fieldbus related wiring details, consult the according [hook-up diagram](#)<sup>11</sup>.
- For information about setting up a fieldbus network with Bronkhorst® instruments, consult the according [fieldbus manual](#)<sup>11</sup>.
- If you need assistance with setting up a fieldbus network, contact your Bronkhorst representative for information.



## 3 Operation

### 3.1 General procedures



Before operating the FLEXI-FLOW, make sure that the equipment has been installed and configured by an authorized engineer and that the installation is approved for use.



To ensure and maintain a safe working area, regularly inspect electrical and fluid lines and connections:

- Prior to each use, check cabling for proper connection, damage and wear. If necessary, replace cables and/or connectors.
- Before, during and after operation, check fluid lines and connections for leaks, damage and wear. If necessary, re-tighten or replace fluid connectors.



During operation, fluid connections must not be loosened or disconnected under any circumstances.



Gas condensation in the instrument can seriously affect its performance and reliability.

- If possible, ensure that the ambient temperature is stable and at equal to or slightly higher than the process gas temperature.
- Always use a clean and dry process gas (preferably with a purity of at least 99.5 %).

#### 3.1.1 Powering up



To maintain control of the fluid system and ensure a safe situation, it is recommended to turn on power before applying fluid pressure and to switch off power only after the fluid system is depressurized.



When pressurizing, prevent pressure shocks by gradually bringing the fluid system to the required operating pressure.

- When powering up, the instrument needs a couple of seconds to start up the electronics and perform a self-test.
- During initialization, the status LED cycles through all [NAMUR status colors](#)<sup>10</sup>.
- After successful initialization, the status LED lights up green to indicate that the instrument is ready to be used.



After powering up, the control valve will act according to the last known setpoint. When setpoint is 0, this means the valve closes (normally open) or stays closed (normally closed). The valve stays closed until the instrument receives a new valid setpoint from the active setpoint source.

#### 3.1.2 First use



Bronkhorst does the utmost to ensure that you receive a clean product. This does not, however, relieve the user of the responsibility to ensure that the equipment and the system in which it is incorporated meet the requirements implied by the intended use of the product. The responsibility for cleaning the equipment to meet such requirements lies exclusively with the user.

#### 3.1.3 After use



- Depending on the properties of the process medium and the (expected) time until the next use, it is advisable to flush the fluid system with a suitable (cleaning) fluid after use.
- If the equipment has been used to process corrosive, reactive or hazardous media (e.g. toxic or flammable), cleaning the fluid system is imperative before it is exposed to air.
- If the equipment is not used for an extended period, the fluid system should be dry after use and after cleaning. If not, it should be purged with a dry, inert gas for a minimum period of 30 minutes.





#### 3.1.4 Powering down

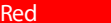

- Prior to powering down the FLEXI-FLOW, the fluid system should be depressurized.
- When depressurizing, prevent pressure shocks by shutting off the fluid supply gradually.

### 3.1.5 Instrument status

The [status LED](#)<sup>8</sup> uses different colors to reflect the current status of the instrument:

	Normal operation
	Failure
	Out of specification
	Maintenance required
	Check function

- The colors are based on the NAMUR NE 107 standard and are a simplified representation of the instrument's [diagnostic data](#)<sup>24</sup>.
- After powering up or restarting the instrument, the status LED cycles through all status colors once.
- After the startup cycle, the status LED assumes the color associated with the current instrument status.

#### Bluetooth

- When Bluetooth is active, the status LED flashes blue once every 3 seconds.
- If the instrument has a Bluetooth connection, the status LED flashes blue twice every 3 seconds.
- Bluetooth communication is not reflected by the status LED.
- Bluetooth indications are not related to the blue NAMUR indication.

#### Zeroing

- During [zero point adjustment](#)<sup>22</sup>, the status LED blinks blue (1 second on, 1 second off).
- The zeroing indication is not related to the blue NAMUR indication.

### 3.1.6 Shut-off valve status

On FLEXI-FLOW models with an integrated shut-off valve (FF-annS), the [status LED on the shut-off valve](#)<sup>8</sup> indicates its state:

Status LED	Valve state	Valve position	
		Normally closed (N.C.)	Normally open (N.O.)
On	actuated	open	closed
Off	inactive	closed	open

## 3.2 Special procedures

### 3.2.1 Changing fieldbus settings (FLOW-BUS/Modbus)

- Upon delivery, the [power and signal connector](#)<sup>8</sup> is configured for FLOW-BUS or Modbus RTU communication interface (see [hook-up diagram](#)<sup>11</sup>), unless specified otherwise at ordering time.
- If necessary, use Bronkhorst FlowSuite to select the required communication interface and configure associated parameters (fieldbus address, baud rate, parity).
- Connect the instrument with Bronkhorst FlowSuite through the support interface or the Bluetooth wireless connection. Communication will be cut off if the selected communication protocol is changed when connected through the power and signal connector.
- If, for some reason, Bronkhorst FlowSuite is not available, see section [Network configuration](#)<sup>34</sup>.



- A USB connection on the support interface provides sufficient power for instrument configuration and monitoring only.
- Configuration using a Bluetooth wireless connection requires powering the instrument through the power connector or support interface.

### Manual address selection

Assuming the default baud rate and parity match the fieldbus configuration, the fieldbus address can be quickly set using the manual [address selector](#) <sup>8</sup> :

- With value 0, the instrument uses the digital address setting
- Values from 1 to 9 override the digital setting

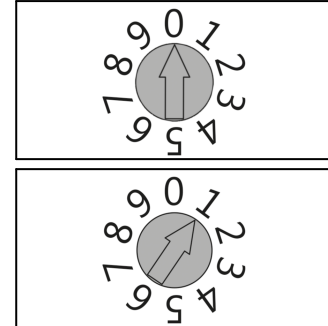

### 3.2.2 Changing fieldbus settings (Ethernet)

- Upon delivery, the Ethernet sockets are configured for PROFINET communication, unless specified otherwise at ordering time.
- In a PROFINET network, an IP address is assigned to the instrument by the Ethernet master.
- If necessary, use Bronkhorst FlowSuite to select the required communication interface and configure address assignment.
- Preferably connect the instrument with Bronkhorst FlowSuite through the support interface or the Bluetooth wireless connection.
- If, for some reason, Bronkhorst FlowSuite is not available, see section [Network configuration](#) <sup>34</sup>.



- A USB connection on the support interface provides sufficient power for instrument configuration and monitoring only.
- Configuration using a Bluetooth wireless connection requires powering the instrument through the power connector or support interface.

### Manual address selection

For Ethernet based protocols other than PROFINET, the 3 manual address selectors can be used to assign an address to the instrument (IP/Node ID/Station alias; again, only if Bronkhorst FlowSuite is not available).



For information about setting the instrument address using the address selectors, refer to the [manual for the according communication protocol](#) <sup>11</sup>.

### MAC address

Because the IP address is set on the device (either dynamic or fixed), it is not necessarily always the same. To be able to track a device in a network with a fixed reference, Ethernet devices also have a MAC address, which cannot be changed and is globally unique. The MAC address is stated on a label affixed to the FLEXI-FLOW.

### 3.2.3 Fluid selection

Fluid sets or mixtures can be stored using Bronkhorst FlowSuite or by direct digital communication (e.g. using a custom-built (PLC) program). To define a fluid set or mixture, only the [formula](#) of the required gas needs to be entered in the appropriate parameter. The associated conversion parameters are filled in automatically.

Whether carried out in Bronkhorst FlowSuite or with direct digital communication, fluid and mixture definition are virtually identical:

To define a [fluid set](#):

1. Select the required *Fluid Set Index*.
2. Enter the formula of the required gas into parameter *Fluid Name* (case-sensitive).

To define a [mix component](#):

1. Select the required *Fluid Set Index*.
2. Select the required *Mix Component Index*.
3. Enter the formula of the required gas into parameter *Mix Component Fluid Name* (case-sensitive).

The following gases can be selected:

Name	Formula
Acetylene	C2H2
Air	Air
Allene	C3H4 #1
Argon	Ar
Carbon dioxide	CO2
Carbon monoxide	CO
Cyclopropane	C3H6 #1
Deuterium	D2 #1
Ethane	C2H6
Ethylene	C2H4
Helium	He
Hydrogen	H2
Krypton	Kr
Methane	CH4
Neon	Ne
Nitrogen	N2
Nitrous oxide	N2O
Oxygen	O2
Perfluoropropane	C3F8
Propane	C3H8
Propylene	C3H6 #2
Propyne	C3H4 #2



- Note that the FLUIDAT® algorithm is case-sensitive regarding fluid names.
- If you need definitions for other gases, contact your Bronkhorst representative.
- Also see parameter section [Fluid set](#)<sup>36</sup> for a complete reference of all digital fluid set parameters.

### 3.2.4 Customizing shut-off valve behavior (FF-annS only)

This section only applies to FLEXI-FLOW models with an integrated shut-off valve (FF-annS).

Upon delivery, actuation of the integrated shut-off valve is linked to the instrument setpoint: the valve is closed as long as setpoint = 0 and open when setpoint > 0.

Using Bronkhorst FlowSuite, the default behavior can be reprogrammed to operate the valve manually.

After setting the valve behavior to manual control, use digital parameter *IO Switch Status* to operate the shut-off valve:

0 = deactivate

1 = activate, observe [default/safe state](#)<sup>24</sup>

257 = activate, ignore default/safe state



**Notes:**

- Make sure the operating mode matches the shut-off valve function (N.C. or N.O.), otherwise the the shut-off valve will close when the control valve is open and vice versa.
- The shut-off valve responds to IO Switch Status only if the operating mode is set to Manual.
- See [Shut-off valve settings \(FF-annS only\)](#)<sup>40</sup> for information about underlying parameter and their meaning.

### 3.2.5 Switching control function



- Bronkhorst FlowSuite automatically adds additional communication channels to the array as regular instruments.
- Although each communication channel represents an individual instrument, all three communication channels of the FLEXI-FLOW have the same node address in the fieldbus network.

#### Control functions

The [multi-parameter functionality](#)<sup>10</sup> enables simultaneous measurement of flow, upstream pressure and downstream pressure, using 3 different communication channels. The selected control function determines whether the instrument uses 1 or 2 communication channels/sensors for measurement and control.

#### Single channel control

Using the single channel control functionality, only a single sensor is used:

Control Function	Communication channel	Instrument function
0	F	Flow control
1	P1	Upstream pressure control
2	P2	Downstream pressure control

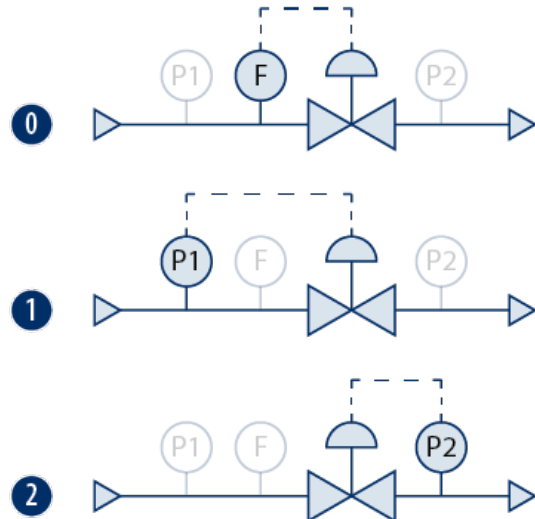

#### Dual channel control

Using the dual channel control functionality, a combination of the flow sensor and 1 of the pressure sensors is used, where either the flow is controlled and the pressure is limited, or vice-versa:

Control Function	Communication channel	Instrument function
3	F + P1	Flow control, with upstream pressure limit
4	F + P2	Flow control, with downstream pressure limit
5	P1 + F	Upstream pressure control, with flow limit
6	P2 + F	Downstream pressure control, with flow limit

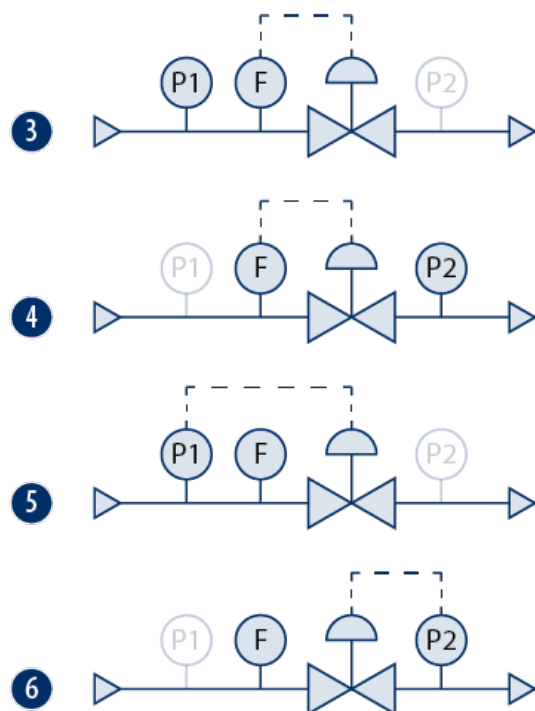

### Switching the control function

- Use parameter [Control Function](#)<sup>29</sup> to set the instrument function.
- Give a setpoint to the controlled value.
- If dual channel control is selected: give a limit to the limited value, using the setpoint parameter of that communication channel.
- See section [Multi-parameter addressing](#)<sup>47</sup> for available parameters.

### 3.2.6 Bluetooth configuration

- The FLEXI-FLOW™ Compact is delivered with Bluetooth disabled.
- Bluetooth can be enabled using Bronkhorst FlowSuite.
- When pairing, the instrument can be recognized by its serial number.
- The first time the instrument is paired with Bronkhorst FlowSuite, a six-digit passkey must be created.
- Subsequently, the instrument can only be paired by entering the passkey that is stored in the instrument.



- After pairing the instrument, Bluetooth can also be enabled or disabled by using digital communication. See parameter section [Bluetooth](#)<sup>42</sup> for the according parameters.
- Configuration using a Bluetooth wireless connection requires powering the instrument through the power connector or support interface.

### 3.2.7 Adjusting zero point

#### Zero-stability

The zero point of a Bronkhorst® flow meter/controller (the measurement signal that indicates the absence of a flow) is factory adjusted at approximately 20 °C and atmospheric pressure (ambient conditions), with the instrument positioned upright. Under normal circumstances (i.e. at stable process conditions), the zero point will remain stable. However, over time several factors can induce a slight deviation of the measured value from the zero point, causing the instrument to detect a flow when in reality there is none. Readjusting the zero point eliminates this deviation.



- After installation or relocation, always check the zero point.
- If the instrument still detects a (steady) flow while all valves are closed and the fluid system is leak tight, adjusting the zero point is recommended.

#### Prerequisites

Zeroing an instrument requires that:

- the ambient conditions (temperature, pressure) match those of the operating environment of the instrument.
- the instrument is filled homogeneously and pressurized with the operational media, according to the typical process conditions.
- the instrument has been warmed up sufficiently.
- there is absolutely no flow through the instrument; preferably, this is achieved by closing a valve immediately after the outlet of the instrument (control valve, shut-off valve).



Blocking the flow through the instrument is essential; zeroing an instrument while there is still a flow will lead to measurement errors.

#### Procedure



Bronkhorst FlowSuite provides a quick and easy way to adjust the zero point of an instrument; the Autozero function automatically performs the procedure described here.

To adjust the zero point using digital communication, set parameter values in the following sequence (see section [Parameters](#)<sup>28</sup> for more information about instrument parameters):

Sequence #	Parameter	Value	Action
1	Setpoint or fSetpoint	0	stop flow
2	Init Reset	64	unlock secured parameters
3	Control Mode	9	enable calibration mode
4	Calibration Mode	0	reset calibration mode
5	Calibration Mode	9	start zeroing

The [status LED](#)<sup>8</sup> starts blinking blue (1 second on, 1 second off), indicating that the procedure is in progress. On completion, the status LED assumes the color of the current [instrument status](#)<sup>10</sup>.

If the procedure is successful, parameter *Calibration Mode* changes to 0 (idle). If the procedure fails, *Calibration Mode* changes to 255.

After zeroing, parameter *Control Mode* returns to its initial value. The output signal should be 0 % (parameter *Measure* = 0).



After performing the procedure, remember to set parameter *Init Reset* to value 82 to lock secured parameters.

### 3.3 Maintenance



*Inexpertly servicing instruments can lead to serious personal injury and/or damage to the instrument or the system it is used in. Servicing must therefore be performed by trained and qualified personnel. Contact your Bronkhorst representative for information about cleaning and calibration. Bronkhorst has trained staff available.*

The FLEXI-FLOW needs no regular maintenance if operated properly, with clean, non-corrosive media, compatible with the wetted materials, avoiding pressure and thermal shocks and vibrations.



- *Before disconnecting or disassembling any fluid system related parts, always make sure the fluid system is depressurized to atmospheric pressure.*
- *When depressurizing, prevent sudden pressure changes by shutting off the fluid supply gradually.*

#### 3.3.1 Cleaning

##### Fluid path

- The instrument's fluid path (the wetted parts) may be purged with a clean, dry and inert gas.
- In case of severe contamination, cleaning the wetted parts may be necessary. This requires the instrument to be returned to the factory.

##### Exterior parts

Exterior parts can be cleaned with a soft, lint free cloth, preferably dry, or, if necessary, moistened with a mild water soluble cleaning agent.



- *Moisten the cloth only slightly, to prevent liquid penetrating the interior and causing damage to the electrical parts.*
- *Only use a water soluble cleaning agent, never an oil based liquid like paint thinner or white spirit, as these might damage parts made of synthetic materials.*

#### 3.3.2 Calibration

The FLEXI-FLOW has been factory calibrated. Periodical inspection, recalibration or verification of the accuracy may be subject to individual requirements of the user. Whenever necessary, contact your Bronkhorst representative for information and/or making arrangements for recalibration.

Bronkhorst certifies that the instrument meets the rated accuracy. Calibration has been performed using measurement standards traceable to the Dutch Metrology Institute (VSL).

### 3.4 Troubleshooting

#### General problems



- *Electronic problems can be traced by restarting the equipment.*
- *If the equipment starts up normally, the measurement and control behavior can be checked by applying fluid pressure.*
- *To track down problems in the fluid system, depressurize the fluid system and disconnect the suspected unit from the process line. Dirt or clogging might be quickly detected by visual inspection of disassembled fluid connections.*



*If you suspect leakage, do not disassemble the device for inspection, but contact your Bronkhorst representative for service or repairs.*

### 3.4.1 Zooming in on NAMUR status

#### Errors and warnings



- Detailed error and warning information can be found by connecting the instrument to a Windows computer running Bronkhorst FlowSuite. Bronkhorst FlowSuite's diagnostic function makes comprehensive diagnostic information accessible based on the [NAMUR status](#)<sup>18</sup>.
- The built-in [diagnostic instrument parameters](#)<sup>44</sup> which Bronkhorst FlowSuite uses for this purpose are also available through the digital communication interface.

### 3.4.2 Default valve state

When a controlling instrument is not powered or cannot communicate with the fieldbus network (if applicable), all electrical valves operated by the instrument (whether integrated or external) automatically return to their default state. The default state is closed for 'normally closed' valves (n/c) and fully open for 'normally open' valves (n/o).

Check the serial number label or the [technical specifications](#)<sup>11</sup> to see which valve type is used on your instrument (if applicable).

### 3.4.3 Common issues

Symptom	Possible cause	Corrective action
No communication	No power supply	<ul style="list-style-type: none"> <li>• Check power supply</li> <li>• Check cable connection</li> <li>• Check cable hook-up</li> </ul>
	Invalid address	Change node address or IP address <ul style="list-style-type: none"> <li>• see <a href="#">Changing fieldbus settings (FLOW-BUS/Modbus)</a><sup>18</sup></li> <li>• or <a href="#">Changing fieldbus settings (Ethernet)</a><sup>19</sup></li> </ul>
	Invalid baud rate	Make sure instrument baud rate matches master/application baud rate
	Other	Reset instrument and/or restart master. If problem persists, contact your Bronkhorst representative
No output signal	No power supply	<ul style="list-style-type: none"> <li>• Check power supply</li> <li>• Check cable connection</li> <li>• Check cable hook-up</li> </ul>
	Invalid control mode (instrument accepts no setpoint)	Check control mode (see <a href="#">Special parameters</a> <sup>45</sup> )
	Valve(s) in default state (normally closed)	Check if connected valves are in default state; solve cause if necessary (see <a href="#">Default valve state</a> <sup>24</sup> )
	Upstream pressure or differential pressure too low	Increase upstream pressure
	Piping, filters and/or control valve clogged or blocked	Clean fluid system (flush with clean, dry air)
	Sensor failure	Contact your Bronkhorst representative



Symptom	Possible cause	Corrective action
Control behavior unstable	Measurement disturbed by vibrations	<ul style="list-style-type: none"> <li>If possible, avoid installation in close proximity of mechanical vibration</li> <li>Reduce sensitivity to vibrations by using a mass block, shock absorbers, and flexible tubing</li> </ul>
	Upstream pressure unstable	Install pressure regulator or increase buffer volume between controlling instruments
	Upstream and/or downstream pressure too high or too low	Adjust pressure and/or set instrument pressure in accordance with actual process pressure
	Wrong process gas selected	Select correct process gas
	Wrong controller settings	Adjust settings (e.g. with Bronkhorst FlowSuite)
	Control valve damaged	Contact your Bronkhorst representative
No flow (sending a setpoint has no effect)	No fluid supply	Check upstream components for obstruction, e.g.: <ul style="list-style-type: none"> <li>fluid lines</li> <li>valves</li> <li>filters</li> </ul>
	Wrong control mode selected	<ul style="list-style-type: none"> <li>Check parameter <a href="#">Control mode</a><sup>46</sup></li> <li>Make sure instrument accepts setpoint from actual setpoint source (bus)</li> </ul>
	Valve(s) in default state (normally closed)	Check if valves are in default state; solve cause if necessary (see <a href="#">Default valve state</a> <sup>24</sup> )
	Upstream pressure or differential pressure out of bounds	Set upstream pressure to a value within specifications
Flow rate never reaches setpoint	<ul style="list-style-type: none"> <li>Fluid system clogged or blocked</li> <li>Sensor obstructed or contaminated</li> </ul>	Flush fluid system with clean, dry air or non-aggressive cleaning liquid (e.g. ethanol or isopropyl alcohol)
	Upstream pressure too low	Increase upstream pressure (to a value within specifications)
	Downstream pressure too high	Decrease downstream pressure (to a value within specifications)
	Differential pressure too low	Make sure differential pressure is within specifications
	Process outlet blocked	Check process outlet and downstream piping
	Process gas condensation	Decrease upstream pressure or increase gas temperature
	Supplied fluid type does not match selected fluid type	Supply equipment with other fluid or change fluid type in instrument configuration
Pressure signal gradually decreasing without setpoint change	Process gas condensation	Decrease upstream pressure or increase gas temperature
Measured value or output signal indicates flow, while there should be none	Fluid system leakage	<ul style="list-style-type: none"> <li>Check fluid system for leakage</li> <li>Follow mounting instructions when installing third party components (e.g. adapters, tubing, valves)</li> </ul>
	Zero point adjustment performed incorrectly	Readjust zero point, following instructions in <a href="#">Adjusting zero point</a> <sup>22</sup>

Symptom	Possible cause	Corrective action
Continuous maximum measured value or output signal	Upstream pressure too high	Check upstream pressure
	Control valve fully open	<ul style="list-style-type: none"> <li>Check parameter <a href="#">Control mode</a> <sup>46</sup></li> <li>In case of normally open valve: check if valve is in default state; resolve cause if necessary (see <a href="#">Default valve state</a> <sup>24</sup>)</li> </ul>
	Sensor failure	Contact your Bronkhorst representative
Fluid system leakage	Bad connection between parts (e.g. ferrules, nuts, tubing, piping, valves)	Follow mounting instructions issued by third party components (e.g. adapters, tubing, valves)

## 3.5 Returns

### 3.5.1 Removal and return instructions

When returning materials, always clearly describe the problem, and, if possible, the work to be done, in a covering letter.

#### Instrument handling:

1. Purge all fluid lines (if applicable)
2. If the instrument has been used with toxic or otherwise hazardous fluids, it must be cleaned before shipping
3. Disconnect all external cabling and tubing and remove the instrument from the process line
4. If applicable, secure movable parts with appropriate transport safety materials, to prevent damage during transportation
5. The instrument must be at ambient temperature before packaging
6. Insert the instrument into a plastic bag and seal the bag
7. Place the bag in an appropriate shipping container; if possible, use the original packaging box

#### Add documentation:

- Reason of return
- Failure symptoms
- Contaminated condition
- Declaration on decontamination



**It is absolutely required to notify the factory if toxic or dangerous fluids have been in contact with the device!**  
This is to enable the factory to take sufficient precautionary measures to safeguard the staff in their repair department.

All instruments must be dispatched with a completely filled in 'Declaration on decontamination'. Instruments without this declaration will not be accepted.



A safety information document containing a 'Declaration on decontamination' form (document no 9.17.032) can be downloaded from the **Service & Support** section of the Bronkhorst website ([www.bronkhorst.com](http://www.bronkhorst.com)).

#### Important:

Clearly note, on top of the package, the customs clearance number of Bronkhorst High-Tech B.V.:

**NL801989978B01**

(only if applicable, otherwise contact your Bronkhorst representative for local arrangements.)

### 3.5.2 Disposal (end of lifetime)

If you are a customer within the European Union and wish to dispose of Bronkhorst® equipment bearing the symbol of a crossed out waste disposal bin, you can return it in accordance with the [removal and return instructions](#) <sup>26</sup>. Bronkhorst will then take care of proper dismantling, recycling and/or reuse (wherever possible). In the covering letter, mention that you are returning the product for disposal.



In countries outside the EU, disposal of electrical and electronic equipment (EEE) may be subject to local or national directives and/or legislation. If applicable, consult local or national authorities to learn how to handle EEE properly in your area.

## 4 Communication interface

### 4.1 Configuration

#### Software

Configuration of the FLEXI-FLOW is best done with **Bronkhorst FlowSuite**, which is developed specifically for easy configuration and monitoring of Bronkhorst® instruments. It can communicate with the FLEXI-FLOW through the [support interface](#)<sup>8</sup> or a Bluetooth wireless connection, without the need to break the operational communication connection.



Bronkhorst FlowSuite can be downloaded from the Bronkhorst website: [www.bronkhorst.com/downloads](http://www.bronkhorst.com/downloads)

#### Support interface

- A regular USB connection provides sufficient power to allow instrument configuration outside of its operating environment.
- During operation, the USB connection can be used to change the configuration or monitor the instrument, while powered through the main power connector.

#### Bluetooth

- The FLEXI-FLOW™ Compact is delivered with Bluetooth disabled; it can be [enabled using Bronkhorst FlowSuite](#)<sup>22</sup>.
- A Bluetooth wireless connection requires the instrument to be powered through the power connector or the support interface.
- The Bluetooth wireless connection is only suitable for configuration and monitoring, but it can be used during operation.

### 4.2 Communication protocol



For information about the use of Bronkhorst® instruments with a specific communication protocol, consult the according [interface manual](#)<sup>11</sup>.

#### FLOW-BUS

Bronkhorst FlowSuite provides a graphical interface to the [ProPar](#)<sup>28</sup> protocol (used by FLOW-BUS), for easy configuration and monitoring of Bronkhorst® instruments.

#### Modbus

In a Modbus system instruments can be monitored and operated using third party software as a master device, such as LabVIEW, ModScan, or a Modbus PLC.

#### Ethernet based protocols

FLEXI-FLOW instruments with an Ethernet based communication interface support the following protocols:

- EtherCAT®
- EtherNet/IP™
- Modbus TCP
- POWERLINK
- PROFINET (default)

In an Ethernet based communication system instruments can be monitored and operated using third party software as a master device, such as TIA Portal (by Siemens).

For most Ethernet based protocols, the master software platform needs a device description file for the according communication protocol. The device description file contains all necessary information to operate the device in the according system, including communication and network configuration, and all available operating parameters with their data types.



Device description files for Bronkhorst® instruments can be downloaded from the product pages on the Bronkhorst website (search for 'fieldbus files').

## 4.3 Parameters



A summary of all digital parameters in this section can be found in the back of this manual.

This section describes the most commonly used parameters for digital operation of the FLEXI-FLOW. Descriptions are grouped by category in tables as shown below:

Type	Access	Range	FlowDDE	FLOW-BUS	Modbus
[type]	RW	[x]...[y]	[DDE par]	[Pro]/[Par]	[address]/[register]



In this manual, parameter names are printed in italics (reverted to normal where embedded in italics, like in this tip).

### Type

Unsigned char	1 byte unsigned integer (0...255)
Unsigned int	2 byte unsigned integer, MSB first (0...65535)
Unsigned long	4 byte unsigned integer, MSB first (0...4294967295)
Float	4 byte floating point, IEEE 32-bit single precision, MSB first
Unsigned char [x]	x byte text string
String	text string of unspecified length

### Access

R	Parameter value can be read
W	Parameter value can be written
	Parameter is secured and only accepts values if parameter <i>Init Reset</i> is set to 'unlocked' first

### Range

Some parameters only accept values within a certain range:

[x]	Minimum value
[y]	Maximum value

### FlowDDE

Parameter number within FlowDDE

### FLOW-BUS

FLOW-BUS uses the ProPar protocol, where parameters are identified by a unique combination of a process number and a parameter number.



- For more information about setting up a FLOW-BUS network with Bronkhorst® instruments, consult the FLOW-BUS manual (see [Documentation](#)<sup>11</sup>).
- For more information about the ProPar protocol, consult the RS-232 manual (see [Documentation](#)<sup>11</sup>).

### Modbus

In the Modbus protocol, parameters are accessed by specifying their unique decimal register number or corresponding PDU address (Protocol Data Unit). The PDU address is the hexadecimal translation of the register number, minus 1, e.g. register number 1 corresponds to PDU address 0x0000, register number 11 corresponds to PDU address 0x000A.

Modbus address blocks are two bytes long. Larger data types use up to 8 subsequent address blocks, resulting in a maximum variable length of 16 bytes. Values longer than the maximum length are truncated.



For more detailed information about setting up a Modbus network with Bronkhorst® instruments, consult the Modbus manual (see [Documentation](#)<sup>11</sup>).

### Other interface protocols

Parameter descriptions in this document are based on their availability with FLOW-BUS, Modbus or RS-232 (ProPar) communication. Due to limitations in, for example, memory capacity or communication properties, definition files for other communication protocols usually do not make all parameters available.



Not all parameters described in this document are necessarily available for all digital communication protocols. For information about parameter access and availability for Bronkhorst® instruments in a network with a specific communication protocol, consult the [manual for the according protocol](#)<sup>11</sup>.

### 4.3.1 Measurement and control

#### Fmeasure

Type	Access	Range	FlowDDE	FLOW-BUS	Modbus
Float	R	-3.4E+38... 3.4E+38	205	33/0	0xA100...0xA101/ 41217...41218

This parameter represents the value of parameter *Measure*, expressed in the selected *Capacity Unit*. Its value is calculated from the dimensionless value of *Measure*, using the fluid set parameters *Capacity 100%* and *Capacity Unit*.

#### Fsetpoint

Type	Access	Range	FlowDDE	FLOW-BUS	Modbus
Float	RW	0...3.4E+38	206	33/3	0xA118...0xA119/ 41241...41242

This parameter represents the value of parameter *Setpoint*, expressed in the selected *Capacity Unit*. Conversion between *Fsetpoint* and the dimensionless value of *Setpoint* uses fluid set parameters *Capacity 100%* and *Capacity Unit*.

#### Control Function

Type	Access	Range	FlowDDE	FLOW-BUS	Modbus
Unsigned char	RW	0..6	432	115/10	0x0E6A/3691

- This parameter determines whether the instrument works as a flow controller or a pressure controller.
- Use the *setpoint* on the associated communication channel to control the flow or pressure (see section [Multi-parameter addressing](#)<sup>47</sup>).
- The selected function is effective immediately.
- The instrument remembers the selected value on restart (persistent setting).

Available functions:

Value	Description
0	Flow
1	Upstream pressure
2	Downstream pressure
3	Flow with upstream pressure limit
4	Flow with downstream pressure limit
5	Upstream pressure with flow limit
6	Downstream pressure with flow limit

#### Measure

Type	Access	Range	FlowDDE	FLOW-BUS	Modbus
Unsigned int	R	0...41942	8	1/0	0x0020/33

This parameter returns a dimensionless representation of the measured flow rate or pressure. Value 32000 corresponds to 100 %, the maximum value corresponds to 131.07 %.

#### Setpoint

Type	Access	Range	FlowDDE	FLOW-BUS	Modbus
Unsigned int	RW	0...32000	9	1/1	0x0021/34

The value of this parameter is a dimensionless representation of the required flow rate or pressure. Value 32000 corresponds to 100 %.

**Temperature**

Type	Access	Range	FlowDDE	FLOW-BUS	Modbus
Float	R	-250...500	142	33/7	0xA138...0xA139/41273...41274

This parameter returns the internal temperature in the instrument housing in °C, which is an approximation of the actual media temperature.

**4.3.1.1 Advanced measurement and control****Setpoint Slope**

Type	Access	Range	FlowDDE	FLOW-BUS	Modbus
Unsigned int	RW	0...30000	10	1/2	0x0022/35

The value of this parameter represents the time it would take to adjust the setpoint if it were changed from 0 to 100%. This feature can be used to smooth 'nervous' controller behavior, e.g. to reduce setpoint overshoot or undershoot. The supported range corresponds to 0...3000 seconds. Default value = 0.

Example:

If *Setpoint Slope* = 100 it will take 10 seconds to adjust the setpoint if it is changed from 0 to 100%. A setpoint change of 20% will take  $(20\%/100\%)*10$  seconds = 2 seconds.

**Valve Output**

Type	Access	Range	FlowDDE	FLOW-BUS	Modbus
Unsigned long	RW	0... 16777215	55	114/1	0xF208...0xF209/61961...61962

This parameter represents the controller output signal for control valve operation.

**4.3.2 Alarms**

*Alarm settings are most easily accessible using Bronkhorst FlowSuite, FlowPlot or FlowView or a Bronkhorst® readout and control unit.*

The built-in alarm functionality can be used to handle different alarm types:

- system errors and warnings
- min/max alarms
- response alarms
- batch alarms
- master/slave alarms

The alarm type can be set with parameter *Alarm Mode*. When an alarm is activated, the type can be read out using parameter *Alarm Info*. An automatic setpoint change can be set using the parameters *Alarm Setpoint Mode* and *Alarm New Setpoint*. It is also possible to set an alarm delay, to prevent overreaction to small disturbances, using parameter *Alarm Delay Time*. The methods by which an alarm can be reset are controlled by *Reset Alarm Enable*.

**Alarm Mode**

Type	Access	Range	FlowDDE	FLOW-BUS	Modbus
Unsigned char	RW	0...3	118	97/3	0x0C23/3108

Available modes:

Value	Description
0	Alarm off
1	Alarm on absolute limits
2	Alarm on limits related to setpoint (response alarm)
3	Alarm at power-up(e.g. after power-down)

**Alarm Info**

Type	Access	Range	FlowDDE	FLOW-BUS	Modbus
Unsigned char	R	0...255	28	1/20	0x0034/53

This parameter provides information about the event type(s) that triggered an alarm situation. The value is a bitwise summation of the issued alarm types; convert the value to binary to see which types are issued. The following alarm types can be issued:

Bit	Value	Type	Description
0	1	Error	Error flag raised
1	2	Warning	Warning flag raised
2	4	Minimum alarm	<i>Measure</i> < <i>Alarm minimum limit</i>
3	8	Maximum alarm	<i>Measure</i> > <i>Alarm maximum limit</i>
4	16	Batch counter alarm	Batch counter reached its limit
5	32	<ul style="list-style-type: none"> <li>• This bit only: Power-up alarm</li> <li>• If combined with bit 2 or 3: Response alarm</li> </ul>	Alarm possibly caused by a power dip Difference between <i>Measure</i> and <i>Setpoint</i> too big
6	64	Master/slave alarm	Setpoint out of limits (caused by <i>Slave factor</i> )
7	128	Hardware alarm	Hardware error

**Alarm Delay Time**

Type	Access	Range	FlowDDE	FLOW-BUS	Modbus
Unsigned char	RW	0...255	182	97/7	0x0C27/3112

This value represents the time in seconds the alarm action will be delayed when an alarm limit has been exceeded. This value also delays the alarm off action if an alarm limit is no longer exceeded.  
Default value = 0.

**Alarm Maximum Limit**

Type	Access	Range	FlowDDE	FLOW-BUS	Modbus
Unsigned int	RW	0...32000	116	97/1	0x0C21/3106

Maximum limit for *Measure* to activate the maximum alarm situation (after *Alarm Delay Time*). Range 0...32000 represents 0...100% signal. *Alarm Maximum Limit* must be greater than *Alarm Minimum Limit*.  
Default value: 0.

**Alarm Minimum Limit**

Type	Access	Range	FlowDDE	FLOW-BUS	Modbus
Unsigned int	RW	0...32000	117	97/2	0x0C22/3107

Minimum limit for *Measure* to activate the minimum alarm situation (after *Alarm Delay Time*). Range 0...32000 represents 0...100% signal. *Alarm Minimum Limit* must be smaller than *Alarm Maximum Limit*.  
Default value: 0.

**Alarm Setpoint Mode**

Type	Access	Range	FlowDDE	FLOW-BUS	Modbus
Unsigned char	RW	0...1	120	97/5	0x0C25/3110

Specifies whether or not to change the setpoint after an alarm situation is activated.

Value	Description
0	No setpoint change (default)
1	Change setpoint to <i>Alarm new setpoint</i>

**Alarm New Setpoint**

Type	Access	Range	FlowDDE	FLOW-BUS	Modbus
Unsigned int	RW	0...32000	121	97/6	0x0C26/3111

New (safe) setpoint during an alarm until reset. Range 0...32000 represents 0...100% setpoint.  
Default value: 0

**Reset Alarm Enable**

Type	Access	Range	FlowDDE	FLOW-BUS	Modbus
Unsigned char	RW	0...15	156	97/9	0x0C29/3114

Available reset methods. The value is a bitwise summation of the enabled methods; convert the value to binary to see which methods are enabled.

Default value: 15 (all bits/methods enabled)

The following methods are supported:

Bit	Value	Description
0	1	By hardware switch (if present)
1	2	Externally (obsolete)
2	4	By parameter <i>Reset</i>
3	8	Automatically (when alarm conditions no longer apply)

**4.3.3 Counter**

- Counter settings are most easily accessible using Bronkhorst FlowSuite, FlowPlot or FlowView or a Bronkhorst® readout and control unit.
- When the instrument is powered down, it remembers the state of the counter. If the counter is active when the instrument is powered down, it is activated when powered up and then continues to count from the value at the time of power down.

**Counter Mode**

Type	Access	Range	FlowDDE	FLOW-BUS	Modbus
Unsigned char	RW	0...2	130	104/8	0x0D08/3337

Available modes:

Value	Description
0	Counter off (default)
1	Counting up continuously
2	Counting up until limit reached (set by <i>Counter Limit</i> )

**Counter Unit**

Type	Access	Range	FlowDDE	FLOW-BUS	Modbus
Unsigned char[4]	RW	see table below	128	104/7	0xE838...0xE839/59449...59450

This parameter contains the name of the counter readout unit.



Counter Unit supports the following values:

Mass	Normal volume (1.01325 bar(a), 0 °C)	Standard volume (1.01325 bar(a), 20 °C)	Custom volume (Capacity Unit Pressure, Capacity Unit Type Temperature)
ug, mg, g, kg	uln, mln, ln, mm3n, cm3n, dm3n, m3n	uls, mls, ls, mm3s, cm3s, dm3s, m3s	ul, ml, l, mm3, cm3, dm3, m3



Parameter [Density](#)<sup>38</sup> (FlowDDE ID 170) is used to calculate Custom volume.

#### Counter Value

Type	Access	Range	FlowDDE	FLOW-BUS	Modbus
Float	RW	0... 10000000	122	104/1	0xE808...0xE809/59401...59402

Current counter value in units selected with parameter *Counter Unit*.

#### Counter Limit

Type	Access	Range	FlowDDE	FLOW-BUS	Modbus
Float	RW	0...9999999	124	104/3	0xE818...0xE819/59417...59418

Counter limit/batch size in units selected with parameter *Counter Unit*.  
Default value: 0.

#### Counter Setpoint Mode

Type	Access	Range	FlowDDE	FLOW-BUS	Modbus
Unsigned char	RW	0...1	126	104/5	0x0D05/3334

Specifies whether or not to change the setpoint after reaching the counter limit.

Value	Description
0	No setpoint change (default)
1	Change setpoint to <i>Counter new setpoint</i>

#### Counter New Setpoint

Type	Access	Range	FlowDDE	FLOW-BUS	Modbus
Unsigned int	RW	0...32000	127	104/6	0x0D06/3335

New (safe) setpoint when a counter limit is reached until reset. Range 0...32000 represents 0...100% setpoint.  
Default value: 0

#### Reset Counter Enable

Type	Access	Range	FlowDDE	FLOW-BUS	Modbus
Unsigned char	RW	0...15	157	104/9	0x0D09/3338

Available reset methods. The value is a bitwise summation of the enabled reset methods; convert the value to binary to see which methods are enabled.

Default value: 7 (bits/methods 0, 1 and 2 enabled)

The following methods are supported:

Bit	Value	Description
0	1	By hardware switch (if present)
1	2	Externally (obsolete)
2	4	By parameter <i>Reset</i>
3	8	Automatically (e.g. when counter value is reset)

#### Totalizer Unit

Type	Access	Range	FlowDDE	FLOW-BUS	Modbus
Unsigned char[4]	RW	See parameter <i>Counter Unit</i>	394	104/18	0xE890...0xE891/59537...59538

This parameter contains the name of the totalizer readout unit.

#### Totalizer Value

Type	Access	Range	FlowDDE	FLOW-BUS	Modbus
Float	RW	0... 10000000	393	104/17	0xE888...0xE889/59529...59530

Current totalizer value in units as selected with parameter *Totalizer Unit*.

### 4.3.4 Network configuration



#### CAUTION

This section is included for reference only. Editing network settings should be done with [Bronkhorst FlowSuite](#)<sup>27</sup>.

Only if Bronkhorst FlowSuite is not available, follow these steps to prepare the instrument for the required communication protocol:

1. Set parameter [Init Reset](#)<sup>45</sup> to value 64 to unlock secured parameters.
2. Set parameter *Fieldbus Interface Index* to value 0 to select the fieldbus interface.
3. Set parameter *Fieldbus1 Selection* to select the required communication protocol.
4. Consult the [manual for the applicable communication interface](#)<sup>11</sup> for information about assigning a node address or an IP address to the instrument.
5. Set parameter [Init Reset](#)<sup>45</sup> to value 82 to lock secured parameters (or restart the instrument).

#### Fieldbus Interface Index

Type	Access	Range	FlowDDE	FLOW-BUS	Modbus
Unsigned char	RW	[0,5]	378	125/7	0x0FA7/4008

- Applicable communication interface (also see [Bluetooth](#)<sup>42</sup>)
- Value must be 0 before changing parameter *Fieldbus1 Selection* or address parameters.
- Default value: 0

Available interfaces:

Value	Description
0	Fieldbus
5	Bluetooth

**Fieldbus1 Selection**

Type	Access	Range	FlowDDE	FLOW-BUS	Modbus
Unsigned char	RW 	[0...2]	305	125/8	0x0FA8/4009

- Selected communication protocol on the power and signal connector.
- Changes are effective immediately.
- The instrument only accepts values that match its hardware configuration (Ethernet/non-Ethernet, see table below).
- Default value (ex factory)
  - non-Ethernet: 1
  - Ethernet: 14

Available protocols:

Value	Description	Non-Ethernet	Ethernet
0	FLOW-BUS	✓	
1	Modbus RTU	✓	
2	ProPar	✓	
11	EtherCAT®		✓
14	PROFINET		✓
18	POWERLINK		✓
19	EtherNet/IP™		✓
20	Modbus TCP		✓

**4.3.4.1 Node address settings**

- On instruments with no Ethernet interface, setting the [manual address selector](#)<sup>18</sup> to a value other than 0 overrides the digital node address setting.
- Changes made to the node address settings will not be restored by a factory reset.
- Although each [communication channel](#)<sup>21</sup> represents an individual instrument, all three communication channels of the FLEXI-FLOW have the same node address.
- For protocol specific address settings, refer to the [manual for the respective communication protocol](#)<sup>11</sup>.

**Fieldbus1 Address**

Type	Access	Range	FlowDDE	FLOW-BUS	Modbus
Unsigned char	RW 	0...255	199	125/10	0x0FAA/4011

**Fieldbus1 Baud Rate**

Type	Access	Range	FlowDDE	FLOW-BUS	Modbus
Unsigned long	RW 	0...1.0E10	201	125/9	0xFD48...0xFD49/64841...64842

**Fieldbus1 Parity**

Type	Access	Range	FlowDDE	FLOW-BUS	Modbus
Unsigned char	RW 	0...2	335	125/12	0x0FAC/4013

The following values are supported:

Value	Description
0	No parity
1	Odd parity
2	Even parity

### Default settings

Network configuration is done ex factory as ordered. The table below shows the supported settings for the available communication protocols.

#### Notes:

- Default settings are printed in bold.
- The node address can only be set by means of the digital parameters for the communication protocols for which default values are indicated. For other communication protocols, use the address selectors on the instrument (see [Changing fieldbus settings \(Ethernet\)](#)<sup>19</sup>).

Protocol	FLOW-BUS	Modbus RTU	POWERLINK
Address	<b>3</b> ...125	<b>1</b> ...247	<b>1</b> ...239
Baud Rate	<b>187500</b>	9600 <b>19200</b> 38400 56000 57600 115200	n/a
Parity	<b>0</b>	0, 1, <b>2</b>	n/a

#### 4.3.4.2 IP address settings



- After changing IP address settings, restart the instrument to apply the changes.
- For protocol specific address settings, refer to the [manual for the respective communication protocol](#)<sup>11</sup>.

#### Fieldbus1 IP Address

Type	Access	Range	FlowDDE	FLOW-BUS	Modbus
String	RW		390	125/14	0xFD70...0xFD77/64881...64888

#### Fieldbus1 Subnet Mask

Type	Access	Range	FlowDDE	FLOW-BUS	Modbus
String	RW		391	125/15	0xFD78...0xFD7F/64889...64896

#### Fieldbus1 Gateway Address

Type	Access	Range	FlowDDE	FLOW-BUS	Modbus
String	RW		392	125/16	0xFD80...0xFD87/64897...64904

### 4.3.5 Fluid set

#### Fluid Set Index

Type	Access	Range	FlowDDE	FLOW-BUS	Modbus
Unsigned char	RW	0...7	24	1/16	0x0030/49

With this parameter, any of the pre-configured fluids (up to 8) can be selected. Each fluid has its specific (configurable) properties, such as *Fluid Name*, *Capacity*, etc.  
Default value: 0 (fluid 1).

Note that the selected value is equal to the fluid number minus 1 (value 0 corresponds to fluid 1, value 1 to fluid 2, etc.)

#### Fluid Name

Type	Access	Range	FlowDDE	FLOW-BUS	Modbus
Unsigned char[10]	RW	-	25	1/17	0x8188...0x818C/33161...33165

This parameter contains the name of the selected fluid.

**Capacity 100%**

Type	Access	Range	FlowDDE	FLOW-BUS	Modbus
Float	RW 	1E-10... 1E+10	21	1/13	0x8168...0x8169/33129...33130

- This parameter represents the 100 % readout/control value (span), expressed in the *Capacity Unit* of the selected fluid.
- *Capacity 100%* is scaled when *Inlet Pressure*, *Fluid Temperature* or *Fluid Name* is changed for the selected fluid.

**Capacity Unit**

Type	Access	Range	FlowDDE	FLOW-BUS	Modbus
Unsigned char[7]	RW 	see below	129	1/31	0x81F8...0x81FB/33273...33276

This parameter represents the unit in which *Capacity 100%* is expressed.

Available units:

Mass flow	Normal volume flow (1.01325 bar(a), 0 °C)	Standard volume flow (1.01325 bar(a), 20 °C)	Custom volume flow ( <i>Capacity Unit Type Pressure</i> , <i>Capacity Unit Type Temperature</i> )
ug/h, ug/min, ug/s, mg/h, mg/min, mg/s, g/h, g/min, g/s, kg/h, kg/min, kg/s	uln/h, uln/min, uln/s, mln/h, mln/min, mln/s, ln/h, ln/min, ln/s, ccn/h, ccn/min, ccn/s, mm3n/h, mm3n/m, mm3n/s, cm3n/h, cm3n/m, cm3n/s, m3n/h, m3n/min, m3n/s, scfh, scfm, scfs, sccm, slm	uls/h, uls/min, uls/s, mls/h, mls/min, mls/s, ls/h, ls/min, ls/s, ccs/h, ccs/min, ccs/s, mm3s/h, mm3s/m, mm3s/s, cm3s/h, cm3s/m, cm3s/s, m3s/h, m3s/min, m3s/s	ul/h, ul/min, ul/s, ml/h, ml/min, ml/s, l/h, l/min, l/s, cc/h, cc/min, cc/s, mm3/h, mm3/m, mm3/s, cm3/h, cm3/m, cm3/s, m3/h, m3/min, m3/s, cfh, cfm, cfs



Because of the maximum string length (7 characters), some unit names are abbreviated, for instance mm3n/m means mm<sup>3</sup>n/min.

**Capacity Unit Type Temperature**

Type	Access	Range	FlowDDE	FLOW-BUS	Modbus
Float	RW 	-273.15... 3.4E+38	245	33/10	0xA150...0xA151/41297...41298

This parameter defines a reference temperature for conversion of the measured mass flow to a volume flow. See also parameters *Capacity Unit* and *Counter Unit*.

**Capacity Unit Type Pressure**

Type	Access	Range	FlowDDE	FLOW-BUS	Modbus
Float	RW 	0...3.4E+38	246	33/11	0xA158...0xA159/41305...41306

This parameter defines a reference pressure for conversion of the measured mass flow to a volume flow. See also parameters *Capacity Unit* and *Counter Unit*.

**4.3.5.1 Advanced fluid set parameters**

Note that the parameters described in this section do not contain any actual measurement values, but only fixed reference values, which can be used for capacity calculations, etc.

**Inlet Pressure**

Type	Access	Range	FlowDDE	FLOW-BUS	Modbus
Float	RW 	0...3.4E+38	178	113/13	0xF168...0xF169/61801...61802

Upstream pressure of the selected fluid in bar(a)

**Outlet Pressure**

Type	Access	Range	FlowDDE	FLOW-BUS	Modbus
Float	RW 	0...3.4E+38	179	113/14	0xF170...0xF171/61809...61810

Downstream pressure of the selected fluid in bar(a).

**Fluid Temperature**

Type	Access	Range	FlowDDE	FLOW-BUS	Modbus
Float	RW 	-250...500	181	113/16	0xF180...0xF181/61825...61826

Temperature of the selected fluid in °C.

**Density**

Type	Access	Range	FlowDDE	FLOW-BUS	Modbus
Float	RW 	0...3.4E+38	170	33/21	0xA1A8...0xA1A9/41385...41386

Density of the selected fluid in kg/m<sup>3</sup>

**Heat Capacity**

Type	Access	Range	FlowDDE	FLOW-BUS	Modbus
Float	RW 	0...3.4E+38	250	113/18	0xF190...0xF191/61841...61842

Heat capacity of the selected fluid in J/kg·K

**Thermal Conductivity**

Type	Access	Range	FlowDDE	FLOW-BUS	Modbus
Float	RW 	0...3.4E+38	251	113/20	0xF1A0...0xF1A1/61857...61858

Thermal conductivity of the selected fluid in W/m·K

**Viscosity**

Type	Access	Range	FlowDDE	FLOW-BUS	Modbus
Float	RW 	0...3.4E+38	252	113/21	0xF1A8...0xF1A9/61865...61866

Dynamic viscosity of the selected fluid in Pa·s

**4.3.5.2 Fluid mixture parameters****Mix Fraction Type**

Type	Access	Range	FlowDDE	FLOW-BUS	Modbus
Unsigned char	RW 	0...2	346	126/4	0x0FC4/4037

Sets the fraction type of the mixture:

Value	Description
0	Volume fraction
1	Mass fraction
2	Mole fraction

**Mix Volume Temperature**

Type	Access	Range	FlowDDE	FLOW-BUS	Modbus
Float	RW 	-250...500	347	126/5	0xFE28...0xFE29/65065...65066

Temperature of the mixture in °C. The value of this parameter is only relevant if *Mix Fraction Type* = 0.

**Mix Volume Pressure**

Type	Access	Range	FlowDDE	FLOW-BUS	Modbus
Float	RW 	0...3.4E+38	348	126/6	0xFE30...0xFE31/65073...65074

Pressure of the mixture in bar(a). The value of this parameter is only relevant if *Mix Fraction Type* = 0.

**Mix Component Index**

Type	Access	Range	FlowDDE	FLOW-BUS	Modbus
Unsigned char	RW	0...4	349	126/7	0x0FC7/4040

Index of the selected component of the mixture (max. 5 components).

**Mix Component Fraction**

Type	Access	Range	FlowDDE	FLOW-BUS	Modbus
Float	RW 	0...1	350	126/8	0xFE40...0xFE41/65089...65090

Mix fraction of the selected mix component (*Mix Component Index*). The value range corresponds to 0...100%. The sum of the all mix fractions must be equal to 1.

If the value is 0, the next component slots are ignored.

**Mix Component Fluid Name**

Type	Access	Range	FlowDDE	FLOW-BUS	Modbus
Unsigned char[10]	RW 	-	351	126/9	0xFE48...0xFE4C/65097...65101

This parameter contains the fluid name of the selected mix component (*Mix Component Index*). This parameter may contain one of two value types:

- Gas name, e.g. 'N2', 'He', 'C3H6 #2'.
- CAS Registry Number, e.g. '7727-37-9', '7440-59-7', '115-07-1'

If the parameter contains no name, the next component slots are ignored.

**4.3.6 Master/slave configuration (FLOW-BUS)**

Normally, there is no communication between the instruments in a fieldbus system. The FLOW-BUS protocol, however, provides a feature to set up a master/slave relationship between two instruments. The typical behavior of a slave instrument is to automatically set its own setpoint relative to the output (measurement value) of its master.

The output value of any instrument in a FLOW-BUS network is automatically available to all other instruments without extra wiring. A slave instrument can also be a master to other instruments.

To set up a master/slave relationship between instruments, first determine which instrument should be the master and which should be the slave, then set *Control Mode* of the slave instrument to 'FLOW-BUS slave' (value 2; also see parameter [Control Mode](#)<sup>46</sup>).

The slave instrument polls the output value of its master periodically and uses the slave factor to set its own setpoint relative to the master's.



To prevent damage to the instruments an/or the system(s) they are connected to, be sure to avoid circular references between devices on the same fieldbus. The FLOW-BUS system does not have a protection mechanism.

**Master Node**

Type	Access	Range	FlowDDE	FLOW-BUS	Modbus
Unsigned char	RW	1...128	158	33/14	n/a

Sets the master node for the instrument.

Note that this parameter is only effective in a FLOW-BUS network (RS-485).

**Slave Factor**

Type	Access	Range	FlowDDE	FLOW-BUS	Modbus
Float	RW	0...500	139	33/1	0xA108...0xA109/41225...41226

The controller output from the master instrument is multiplied by *Slave Factor*/100 % to get the slave instrument setpoint. In systems other than FLOW-BUS, *Slave Factor* is effective only if *Control Mode* is set to 'Analog slave', and the analog output signal of the master instrument is redirected to the input of the slave instrument.

Example:

- master output = 80 %
  - *Slave Factor* = 50
- ⇒ slave instrument setpoint = 80 % x 50 %/100 % = 40 %

**4.3.7 Shut-off valve settings (FF-annS only)**

This section only applies to FLEXI-FLOW models with an integrated shut-off valve (FF-annS).

Upon delivery, actuation of the shut-off valve is linked to the instrument setpoint: the valve is closed as long as setpoint = 0 and open when setpoint > 0.

In Bronkhorst FlowSuite, the default behavior can be reprogrammed to operate the valve manually. Manual operation is then carried out using parameter *IO Switch Status*.

Only if Bronkhorst FlowSuite is not available, follow these steps to modify the operating mode of the shut-off valve via digital communication:

1. Set parameter *Actuator Index* to value 1 to select the shut-off valve for adjustment.
2. Set parameter *Actuator Type* to select the operating mode to manual control.

**Notes:**

- Make sure the operating mode matches the shut-off valve function (N.C. or N.O.), otherwise the the shut-off valve will close when the control valve is open and vice versa.
- The shut-off valve responds to *IO Switch Status* only if the operating mode is set to Manual (*Actuator Type* 5 or 6).

**Actuator Index**

Type	Access	Range	FlowDDE	FLOW-BUS	Modbus
Unsigned char	RW	0, 1	433	114/0	0x0E40/3649

This parameter selects the instrument valve for reprogramming. Supported values:

Value	Description
0	Control valve
1	Shut-off valve

**Actuator Type**

Type	Access	Range	FlowDDE	FLOW-BUS	Modbus
Unsigned char	RW	See below	80	114/6	0x0E46/3655

This parameter sets the operating mode of the selected valve. Make sure the operating mode matches the shut-off valve function (N.C. or N.O.), otherwise the the shut-off valve will close when the control valve is open and vice versa.

Supported values:

Value	Operating mode
5	Manual, N.C.
6	Manual, N.O.
7	Automatic, N.C.
8	Automatic, N.O.
255	Disabled



**IO Switch Status**

Type	Access	Range	FlowDDE	FLOW-BUS	Modbus
Unsigned long	RW	See below	288	114/31	0xF2F8...0xF2F9/62201...62202

This parameter actuates the shut-off valve, but only if its operating mode is set to Manual (parameter *Actuator Type*). Depending on the valve type, actuation opens or closes it:

Actuation	Normally open	Normally closed
Inactive	open	closed
Active	closed	open

The value of *IO Switch Status* is a bitwise summation of 2 function settings; convert the decimal value to binary to see the status of each bit. To activate one or both bits, write the sum of their decimal (or hex) values to the register.

Parameter *IO Switch Status* supports the following settings (other bits are ignored):

Bit	Function	Value	Description
0	Actuation switch	0	Valve inactive (not powered)
		1	Valve active (powered)
8	Observe or ignore instrument safe state*	0	Observe default/safe state; actuation disabled if the instrument is in default/safe state.
		256	Ignore default/safe state; shut-off valve actuation enabled even if the instrument is in default/safe state.

\*) See parameter [Special parameters - Control Mode](#)<sup>46</sup>.



- Immediately after powering-up, both bits are inactive.
- In the event of communication faults, the shut-off valve will assume its [default state](#)<sup>24</sup> (regardless of the value of bit 8).

**4.3.8 Device identification****User Tag**

Type	Access	Range	FlowDDE	FLOW-BUS	Modbus
Unsigned char[16]	RW	-	115	113/6	0xF130...0xF137/ 61745...61752

With this parameter, the instrument can be given a custom tag name, with a maximum of 16 characters.

**Customer Model**

Type	Access	Range	FlowDDE	FLOW-BUS	Modbus
Unsigned char[16]	RW	-	93	113/4	0xF120...0xF127/ 61729...61736

This parameter is used to add extra information to the model number information, such as a customer-specific model number.

**Serial Number**

Type	Access	Range	FlowDDE	FLOW-BUS	Modbus
Unsigned char[20]	R	-	92	113/3	0xF118...0xF11F/ 61721...61728

Instrument serial number for identification.

**BHT Model Number**

Type	Access	Range	FlowDDE	FLOW-BUS	Modbus
Unsigned char[35]	RW	-	91	113/2	0xF110...0xF117/ 61713...61720

This parameter shows the Bronkhorst® instrument model type information.

**Firmware Version**

Type	Access	Range	FlowDDE	FLOW-BUS	Modbus
Unsigned char[16]	R	-	105	113/5	0xF128...0xF12A/ 61737...61739

Revision number of the firmware

**Identification Number**

Type	Access	Range	FlowDDE	FLOW-BUS	Modbus
Unsigned char	RW 	0...255	175	113/12	0x0E2C/3629

Bronkhorst® (digital) device type identification number.

**Device Type**

Type	Access	Range	FlowDDE	FLOW-BUS	Modbus
Unsigned char[6]	R	-	90	113/1	0xF108...0xF10A/ 61705...61707

Device type information string; this parameter contains an abbreviation referring to the identification number.

**4.3.9 Bluetooth****Fieldbus Interface Index**

Type	Access	Range	FlowDDE	FLOW-BUS	Modbus
Unsigned char	RW	[0,5]	378	125/7	0x0FA7/4008

- Applicable communication interface (also see [Network configuration](#)  <sup>34</sup>).
- Change the value to 5 before editing *Fieldbus Connection Mode* or *Fieldbus Passkey*.
- Default value: 0

Available interfaces:

Value	Description
0	Fieldbus
5	Bluetooth

**Fieldbus Connection Mode**

Type	Access	Range	FlowDDE	FLOW-BUS	Modbus
Unsigned int	RW	[0,1]	427	125/24	0x0FB8/4025

- The FLEXI-FLOW™ Compact is delivered with Bluetooth switched off.
- Value modifications become effective immediately.
- The instrument remembers the selected mode on restart (persistent setting).

Available modes:

Value	Description
0	Off
1	On

**Fieldbus Passkey**

Type	Access	Range	FlowDDE	FLOW-BUS	Modbus
Unsigned long	RW	0...999999	428	125/25	0x0FB9...0x0FBA/ 4026...4027

- PIN code required to make a Bluetooth connection with the instrument (pair).
- Default value: -1

### 4.3.10 Operational history

#### Single values

Name	Type	Access	Range	FlowDDE	FLOW-BUS	Modbus*
BHT1 Production Date	String	R		94	118/1	0xF608/62985 [8]
BHT2 Operation Time	Unsigned int	R		95	118/2	0x0EC2/3779 [1]
BHT3 Flow Time	Unsigned long	R		96	118/3	0xF618/63001 [2]
BHT4 Actuation Count	Unsigned int	R		97	118/4	0x0EC4/3781 [1]
BHT5 Mode Change Count	Unsigned char	R		98	118/5	0x0EC5/3782 [1]
BHT6 Watchdog Reset Count	Unsigned char	R		99	118/6	0x0EC6/3783 [1]
BHT7 Power Cycle Count	Unsigned char	R		100	118/7	0x0EC7/3784 [1]
BHT8 Normal Reset Count	Unsigned char	R		101	118/8	0x0EC8/3785 [1]
BHT9 NVRAM Error Count	Unsigned long	R		102	118/9	0xF648/63049 [2]
BHT12 NVRAM Write Count	Unsigned long	R		330	118/12	0xF660/63073 [2]

\*) numbers in square brackets indicate the number of blocks/registers occupied by a parameter.

#### Statistical data

- Statistical data is stored in a matrix, where each item is represented by 1 row, identified by an index.
- Setting the index to the required value populates the other parameters with the associated statistical data.

Name	Type	Access	Range	FlowDDE	FLOW-BUS	Modbus*
Operational History Parameter Index	Unsigned int	RW	see below	420	118/23	0x0ED7/3800 [1]
Operational History Parameter Name	String	R		421	118/24	0xF6C0/63169 [8]
Operational History Minimum Value	Float	R		422	118/25	0xF6C8/63177 [2]
Operational History Maximum Value	Float	R		423	118/26	0xF6D0/63185 [2]
Operational History Average	Float	R		424	118/27	0xF6D8/63193 [2]
Operational History Standard Deviation	Float	R		425	118/28	0xF6E0/63201 [2]

\*) numbers in square brackets indicate the number of blocks/registers occupied by a parameter.

The following statistical items are available:

Index	Parameter name
0	Flow (lifetime)
1	Flow (last 30 days)
2	Flow (last 24 hours)
3	Upstream pressure (lifetime)
4	Upstream pressure (last 30 days)
5	Upstream pressure (last 24 hours)
6	Downstream pressure (lifetime)
7	Downstream pressure (last 30 days)
8	Downstream pressure (last 24 hours)
9	Flow setpoint (lifetime)
10	Flow setpoint (last 30 days)
11	Flow setpoint (last 24 hours)
12	Upstream pressure setpoint (lifetime)
13	Upstream pressure setpoint (last 30 days)
14	Upstream pressure setpoint (last 24 hours)
15	Downstream pressure setpoint (lifetime)
16	Downstream pressure setpoint (last 30 days)
17	Downstream pressure setpoint (last 24 hours)
18	Actuator output (lifetime)
19	Actuator output (last 30 days)
20	Actuator output (last 24 hours)
21	Sensor bridge voltage (lifetime)
22	Sensor bridge voltage (last 30 days)
23	Sensor bridge voltage (last 24 hours)
24	Temperature (lifetime)
25	Temperature (last 30 days)
26	Temperature (last 24 hours)

### 4.3.11 Diagnostics

#### General information

Name	Type	Access	Range	FlowDDE	FLOW-BUS	Modbus*
Instrument NAMUR Status Current instrument status	Unsigned char	R	see below	418	118/0	0x0EC0/3777 [1]

**Event details**

- Diagnostic event data is stored in a matrix, where each row represents 1 event, identified by an index.
- The event matrix has a maximum size of 50 rows and is updated cyclically.
- Setting *Diagnostic Event Index* to the required value populates the other parameters with the associated event data.

Name	Type	Access	Range	FlowDDE	FLOW-BUS	Modbus*
Diagnostic Newest Event Index Index of the most recently added event Refers to <i>Diagnostic Event Index</i>	Unsigned int	R	0...49	411	118/14	0x0ECE/3791 [1]
Diagnostic Event Index Unique row identifier	Unsigned int	RW	0...49	412	118/15	0x0ECF/3792 [1]
Diagnostic Event Code	Unsigned int	R		413	118/16	0x0ED0/3793 [1]
Diagnostic Event Description	String	R		414	118/20	0xF6A0/63137 [8]
Diagnostic Event Active Is the event still applicable? Updated if the cause of the event has been eliminated	Unsigned char	R	see below	415	118/17	0x0ED1/3794 [1]
Diagnostic Event NAMUR Status Instrument status at the time of event occurrence	Unsigned char	R	see below	416	118/18	0x0ED2/3795 [1]
Diagnostic Event Timestamp	Unsigned long	R		417	118/21	0xF6A8/63145 [2]

\*) numbers in square brackets indicate the number of blocks/registers occupied by a parameter.

**Value ranges**

Parameter	Value	Description
Diagnostic Event Active	0	false
	1	true
NAMUR Status (also see section <a href="#">Instrument status</a> <sup>18</sup> )	0	Normal operation
	1	Maintenance required
	2	Out of specification
	4	Check function
	8	Failure

**4.3.12 Special parameters****Init Reset**

Type	Access	Range	FlowDDE	FLOW-BUS	Modbus
Unsigned char	RW	82/64	7	0/10	0x000A/11

*Init Reset* is used to unlock secured parameters (marked with a  symbol) for writing. It supports the following values:

Value	Description
64	unlocked, secured parameters can be read and written to
82	locked, secured parameters are read-only

At power-up, *Init Reset* is always set to 'Locked' (value 82).

**Reset**

Type	Access	Range	FlowDDE	FLOW-BUS	Modbus
Unsigned char	R	0...7	114	115/8	0x0E68/3689

This parameter is used to reset the program, counter or alarms (alarms are reset on all channels).

Value	Description
0	No reset
1	Reset counter
2	Reset alarm
3	Reset counter
4	Reset and disable counter
5	Reset firmware program (soft reset)
6	Reset <i>Alarm info</i> error bit
7	Reset <i>Alarm info</i> warning bit



- Resetting alarms or the counter can be disabled by Reset Alarm Enable or Reset Counter Enable respectively.
- Reset value 2 resets alarms on all three communication channels, unless resetting is disabled for 1 or more channels.

### Wink

Type	Access	Range	FlowDDE	FLOW-BUS	Modbus
Unsigned char [27]	W	0...9	1	0/0	0x0000/1

Sending any decimal value between 1 and 9\* to this parameter makes the status LED flash white for that number of seconds. This can be useful in order to identify a specific device in a large fieldbus network.

\*) On Modbus the required number of seconds is represented by these values:

No. of seconds	Wink value
1	12544
2	12800
3	13056
4	13312
5	13568
6	13824
7	14080
8	14336
9	14592

### Control Mode

Type	Access	Range	FlowDDE	FLOW-BUS	Modbus
Unsigned char	RW	0...255	12	115/1	0x0024/37

*Control Mode* is used to select different control modes of the instrument and determines from which source(s) it accepts a setpoint.

The following modes are available:

Value	List option	Description	Setpoint source
0	Bus/RS232	Normal operation	Fieldbus
2	FLOW-BUS slave	Acting as slave instrument on FLOW-BUS	FLOW-BUS master
3	Valve close	Controller disabled, valve closed	
4	Controller idle	Controller disabled, valve frozen in current position	
7	Setpoint 100%	Setpoint fixed at 100 %	
8	Valve fully open	Controller disabled, valve fully open	
9	Calibration mode	Calibration mode enabled	
12	Setpoint 0%	Setpoint fixed at 0%	
18	RS232	Controlling, <a href="#">default/safe state</a> <input type="checkbox"/> <sup>24</sup> disabled	Fieldbus
20	Valve steering	Controller disabled, setpoint redirected to <i>Valve Output</i>	
22	Valve safe state	Instrument in <a href="#">default/safe state</a> <input type="checkbox"/> <sup>24</sup>	

- Default value: 0
- If *Control mode* is changed to value 9 or 18, the instrument returns to the default value at the next power-up or reset. Other values are persistent.
- *Control mode* 18 prevents the instrument from assuming its [default/safe state](#)<sup>24</sup> in the event of a digital communication failure.
- The column labeled *List option* shows the control modes as used in Bronkhorst® software (which explains the RS-232 references, although the FLEXI-FLOW has no such interface).

#### Calibration Mode

Type	Access	Range	FlowDDE	FLOW-BUS	Modbus
Unsigned char	RW 	0, 9, 255	58	1/4	0x0E61/3682

After enabling calibration mode by means of parameter *Control Mode*, this parameter is used to start the autozero function of the flow sensor. The following modes are supported:

Value	Description
0	Idle (no action)
9	Start zeroing
255	Error (result of previous calibration mode)

## 4.4 Multi-parameter addressing

This section lists all parameters that are available on all [3 communication channels](#)<sup>21</sup> (F, P1, P2), including their FLOW-BUS and Modbus addresses. Categories are consistent with section [Parameters](#)<sup>28</sup>. See the according subsections for detailed parameter descriptions.

#### General address derivation using offset

In a **Modbus** system, parameters of communication channels P1 and P2 can be accessed by applying an offset to the Modbus PDU address of the parameter on channel F:

- For address range 0x0000...0x0FFF, add 0x20 to the Modbus PDU address for channel P1, or 0x40 for channel P2.
- For address range 0x8000...0xFFFF, add 0x100 to the Modbus PDU address for channel P1, or 0x200 for channel P2.

On **FLOW-BUS**, parameters of communication channels P1 and P2 can be accessed by applying an offset to the process number of the parameter on channel F:

- Add 1 to the process number for channel P1.
- Add 2 to the process number for channel P2.

#### Measurement and control

Name	Channel F (flow)		Channel P1 (upstream pressure)		Channel P2 (downstream pressure)	
	FLOW-BUS	Modbus	FLOW-BUS	Modbus	FLOW-BUS	Modbus
Measure (8)	1/0	0x0020	2/0	0x0040	3/0	0x0060
Setpoint (9)	1/1	0x0021	2/1	0x0041	3/1	0x0061
Setpoint Slope (10)	1/2	0x0022	2/2	0x0042	3/2	0x0062
Temperature (142)	33/7	0xA138	34/7	0xA238	35/7	0xA338
Fmeasure (205)	33/0	0xA100	34/0	0xA200	35/0	0xA300
Fsetpoint (206)	33/3	0xA118	34/3	0xA218	35/3	0xA318

**Fluid set**

Communication channels P1 and P2 do not support the definition of fluid sets. The fluid set parameters on channels P1 and P2 are used only for measurement and control data conversion.

Name	Channel F (flow)		Channel P1 (upstream pressure)		Channel P2 (downstream pressure)	
	FLOW-BUS	Modbus	FLOW-BUS	Modbus	FLOW-BUS	Modbus
Capacity (21)	1/13	0x8168	2/13	0x8268	3/13	0x8368
Capacity Unit (129)	1/31	0x81F8	2/31	0x82F8	3/31	0x83F8
Capacity Unit Type Temperature (245)	33/10	0xA150	34/10	0xA250	35/10	0xA350
Capacity Unit Type Pressure (246)	33/11	0xA158	34/11	0xA258	35/11	0xA358
Density (170)	33/21	0xA1A8	34/21	0xA2A8	35/21	0xA3A8

**Alarms**

Name	Channel F (flow)		Channel P1 (upstream pressure)		Channel P2 (downstream pressure)	
	FLOW-BUS	Modbus	FLOW-BUS	Modbus	FLOW-BUS	Modbus
Alarm Info (28)	1/20	0x0034	2/20	0x0054	3/20	0x0074
Alarm Maximum Limit (116)	97/1	0x0C21	98/1	0x0C41	99/1	0x0C61
Alarm Minimum Limit (117)	97/2	0x0C22	98/2	0x0C42	99/2	0x0C62
Alarm Mode (118)	97/3	0x0C23	98/3	0x0C43	99/3	0x0C63
Alarm Setpoint Mode (120)	97/5	0x0C25	98/5	0x0C45	99/5	0x0C65
Alarm New Setpoint (121)	97/6	0x0C26	98/6	0x0C46	99/6	0x0C66
Alarm Delay Time (182)	97/7	0x0C27	98/7	0x0C47	99/7	0x0C67
Reset Alarm Enable (156)	97/9	0x0C29	98/9	0x0C49	99/9	0x0C69

**4.5 Gateway (multi-channel systems)**

The FLEXI-FLOW™ concept offers the option of multi-channel systems, combining multiple instruments into one microfluidic system. The following functional modules can be configured into one compact sub-system: mass flow meter or controller, pressure meter or controller, shut-off valve, mixing chamber.

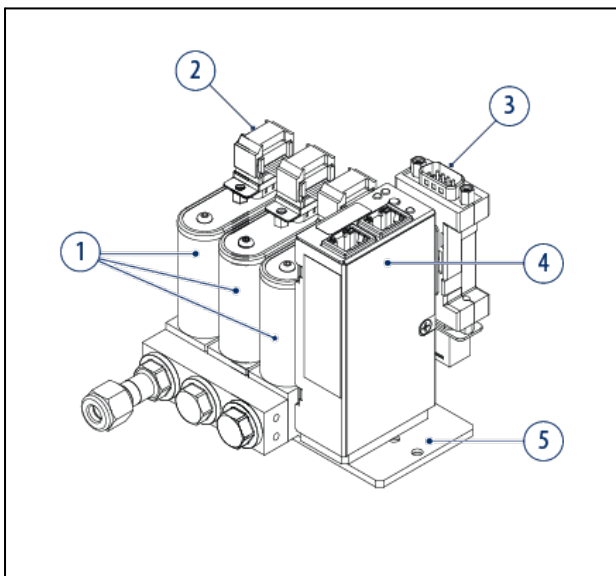

1. Multiple instruments
2. Flat cable
3. Power connector
4. Gateway
5. Mounting plate



On communication platforms other than FLOW-BUS or Modbus RTU, Bronkhorst® instruments can be controlled through a gateway. 1 gateway can accommodate up to 8 Bronkhorst® instruments.



*When communicating through a gateway, parameter addressing is slightly different from what is described in this document.*

- *For information about parameter addressing when using a Bronkhorst® gateway for PROFIBUS DP or PROFINET communication, consult the [manual for the according communication protocol](#)<sup>11</sup>.*
- *For information about parameter addressing on third party gateways, consult the manual supplied by the gateway manufacturer..*



## Parameter index

### Parameters

		Fluid Name	36
		Fluid Set Index	36
		Parameters - Fluid set (advanced)	
		Density	38
		Fluid Temperature	38
		Heat Capacity	38
		Inlet Pressure	37
		Outlet Pressure	38
		Thermal Conductivity	38
		Viscosity	38
		Parameters - Fluid set (mixture)	
		Mix Component Fluid Name	39
		Mix Component Fraction	39
		Mix Component Index	39
		Mix Fraction Type	38
		Mix Volume Pressure	39
		Mix Volume Temperature	38
		Parameters - Master/Slave	
		Master Node	39
		Slave Factor	40
		Parameters - Measurement and control	
		Control Function	29
		Fmeasure	29
		Fsetpoint	29
		Measure	29
		Setpoint	29
		Setpoint Slope	30
		Temperature	30
		Valve Output	30
		Parameters - Network configuration	
		Fieldbus Interface Index	34
		Fieldbus1 Address	35
		Fieldbus1 Baud Rate	35
		Fieldbus1 Gateway Address	36
		Fieldbus1 IP Address	36
		Fieldbus1 Parity	35
		Fieldbus1 Selection	35
		Fieldbus1 Subnet Mask	36
		Parameters - Operational History (single)	
		Actuation Count	43
		Flow Time	43
		Mode Change Count	43
		Normal Reset Count	43
		NVRAM Error Count	43
		NVRAM Write Count	43
		Operation Hours	43
		Power Cycle Count	43
		Production Date	43
		Watchdog Reset Count	43
Parameters - Alarms			
Alarm Delay Time	31		
Alarm Info	31		
Alarm Maximum Limit	31		
Alarm Minimum Limit	31		
Alarm Mode	30		
Alarm New Setpoint	32		
Alarm Setpoint Mode	31		
Reset Alarm Enable	32		
Parameters - Bluetooth			
Fieldbus Connection Mode	42		
Fieldbus Interface Index	42		
Fieldbus Passkey	42		
Parameters - Counter			
Counter Limit	33		
Counter Mode	32		
Counter New Setpoint	33		
Counter Setpoint Mode	33		
Counter Unit	32		
Counter Value	33		
Reset Counter Enable	33		
Totalizer Unit	34		
Totalizer Value	34		
Parameters - Device identification			
BHT Model Number	41		
Customer Model	41		
Device type	42		
Firmware version	42		
Identification number	42		
Serial Number	41		
User Tag	41		
Parameters - Diagnostics			
Diagnostic Event Active	44		
Diagnostic Event Code	44		
Diagnostic Event Description	44		
Diagnostic Event Index	44		
Diagnostic Event NAMUR Status	44		
Diagnostic Event Timestamp	44		
Diagnostic Newest Event Index	44		
Instrument NAMUR Status	44		
Parameters - Fluid set			
Capacity 100%	37		
Capacity Unit	37		
Capacity Unit Type Pressure	37		
Capacity Unit Type Temperature	37		

---

Parameters - Operational History (statistics)	
Operational History Average	43
Operational History Maximum Value	43
Operational History Minimum Value	43
Operational History Parameter Index	43
Operational History Parameter Name	43
Operational History Standard Deviation	43
Parameters - Shut-off valve settings	
Actuator Index	40
Actuator Type	40
IO Switch Status	41
Parameters - Special	
Control Mode	46
Init Reset	45
Reset	45
Wink	46